

COLUMNS DETAILS

Gran Via

Hall 1	C101 to C105	page 3
Hall 2	C201 to C205	page 9
Hall 3	C301 to C305	page 19
Hall 4	C401 to C405	page 24
Hall 5	C501 to C505	page 28
Hall 6	C601 to C605	page 34
Hall 7	C701 to C705	page 39
Underwalkway	CU01 to CU04	page 45
Hall 8.0	C8001 to C8005	page 50
Hall 8.1	C8101 to C8105	page 56

INSTRUCTIONS

Please check the floorplans to locate each column type name.

Columns are named as

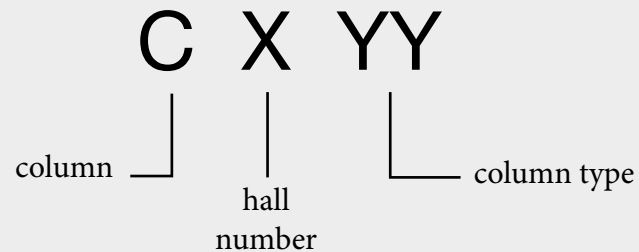

Technical constraints

No construction elements can be supported by or onto walls, columns or other fixed elements of the halls, and adequate protection must be used or a safe distance must be maintained between the construction materials and the hall walls. In no case should the stability of any object, assembly or structure be conditioned to the infrastructure of Fira de Barcelona. All elements must be self-supporting and self-standing.

Hall columns inside the stand can be cladded without damaging them and in accordance with the permitted height regulations, taking into account the fact that, in the case of connection boxes, these boxes can always be registered. Vinyl columns can only be installed by official Fira suppliers. This service can be contracted through the sales department of Fira Barcelona (www.servifira.com)

In the case of cladding or decorating columns with fire equipment, extinguishers, fire alarm call points, signage or any other informational element of the venue, they must always be visible and accessible. They cannot be manipulated nor broken down.

Cladding policy

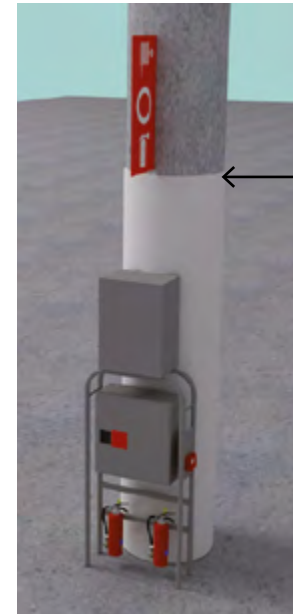

A vinyl can reach up to the upper fire signage



The cladding cannot cover the upper signage

Some of the fire equipment in Halls 3, 4 and 6 include fixed switchboards. These columns are marked with the letter *b* after the type name. The switchboards can be cladded but need to remain accessible during build up and dismantling to other exhibitors.

HALL 1 Floorplan

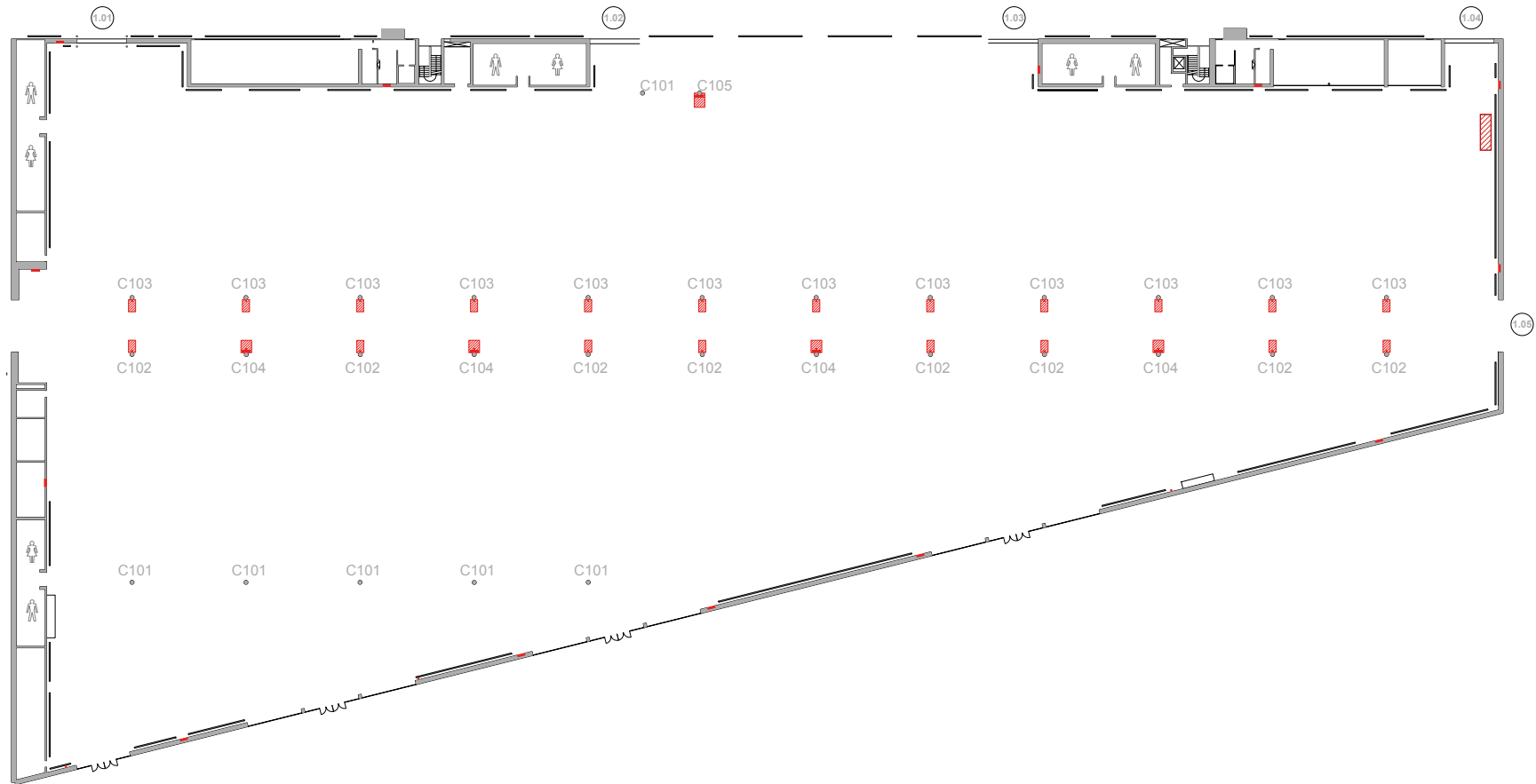

Column details - Gran Via Hall 1

Column type C101

Floorplan & Dimensions

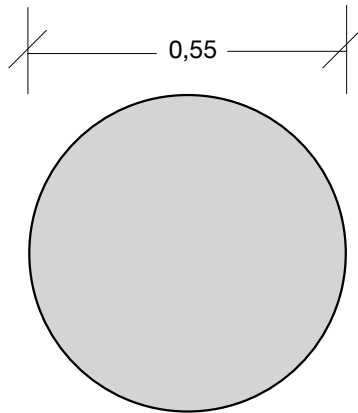

Picture



Column details - Gran Via Hall 1

Column type C102

Floorplan & Dimensions

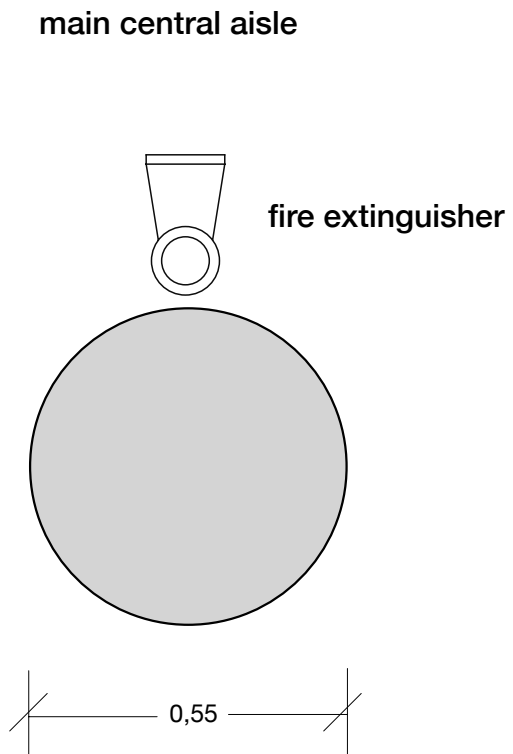

Picture

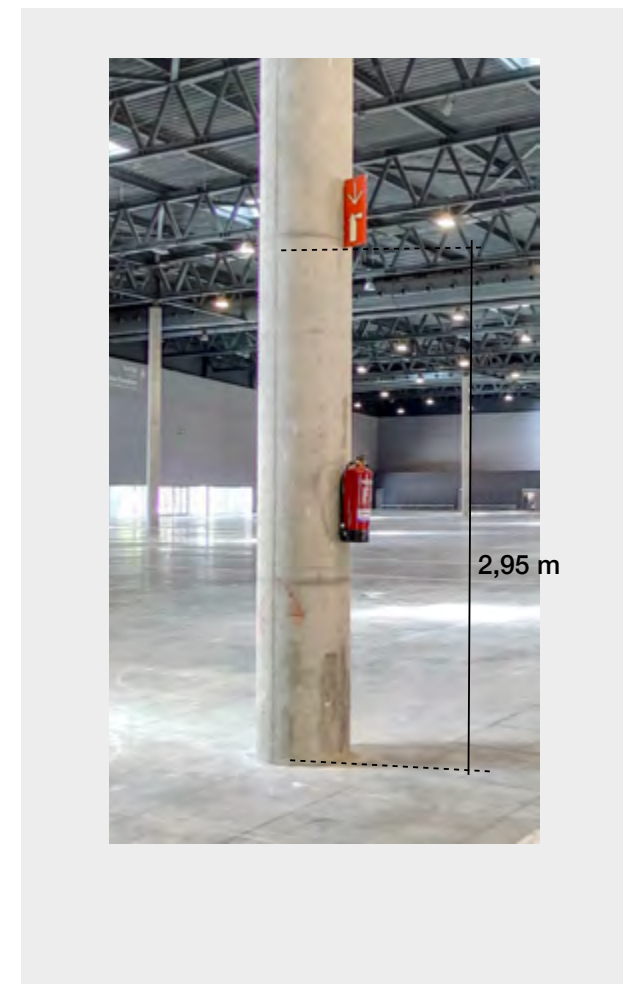

Column details - Gran Via Hall 1

Column type C103

Floorplan & Dimensions

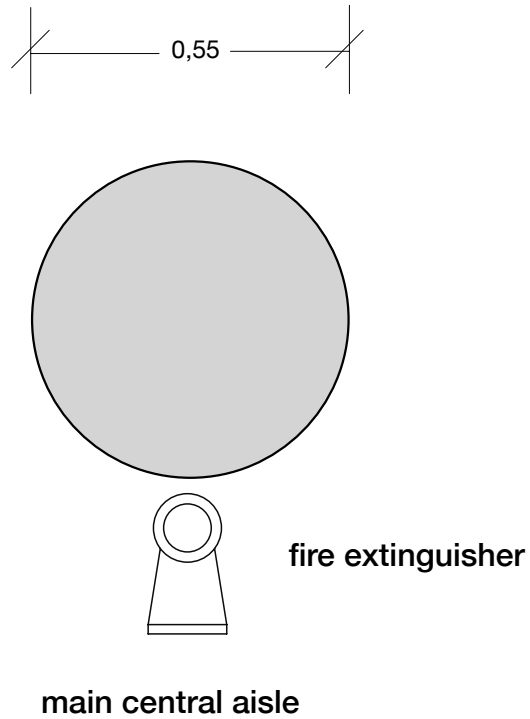

Picture

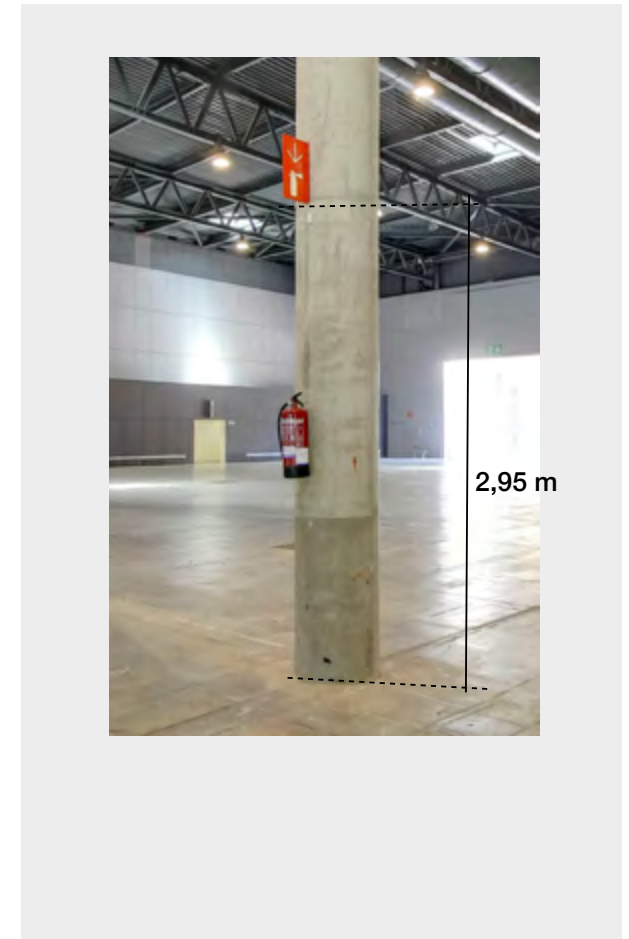

Column details - Gran Via Hall 1

Column type C104

Floorplan & Dimensions

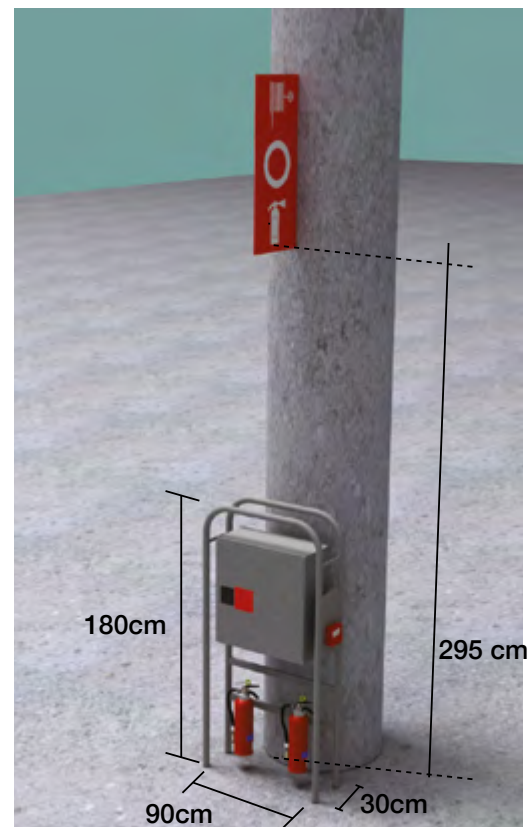
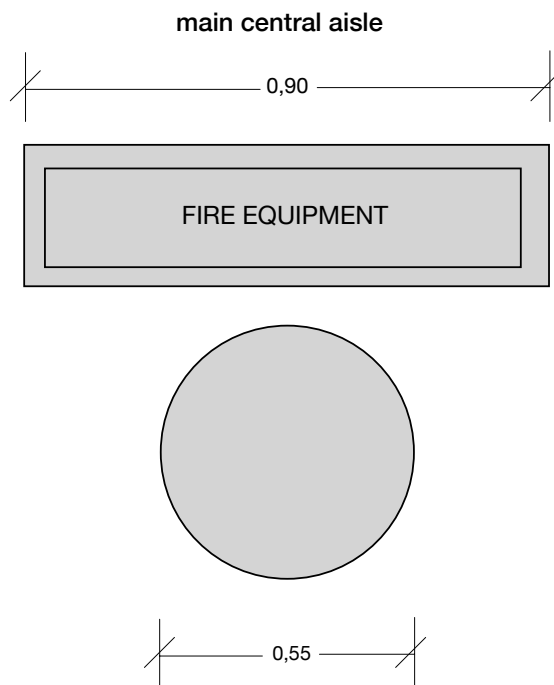

Note that the fire extinguisher equipment and sign need to remain accessible and visible at all times.

Picture

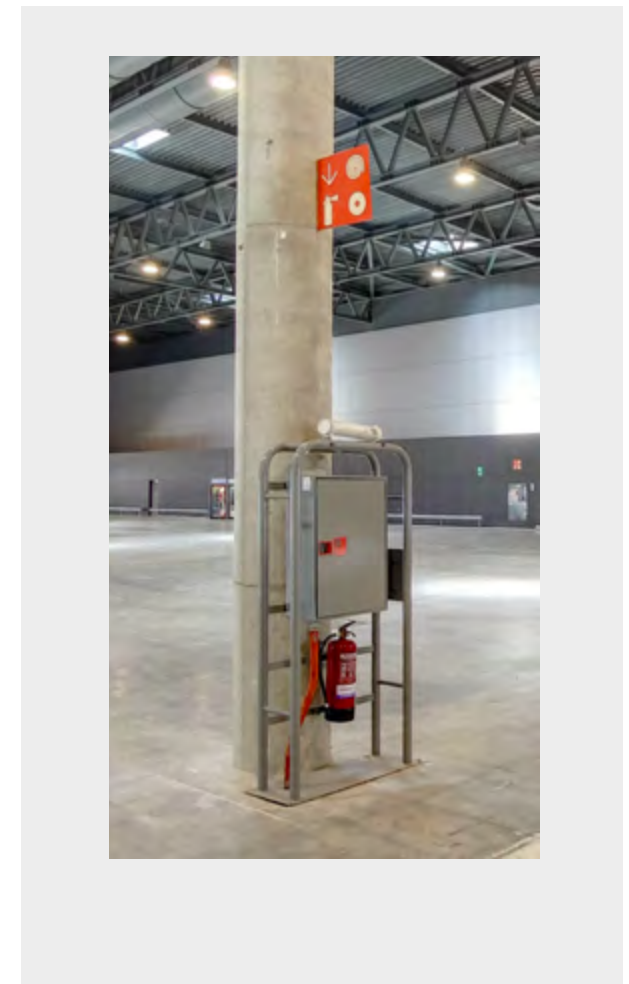

Column details - Gran Via Hall 1

Column type C105

Floorplan & Dimensions

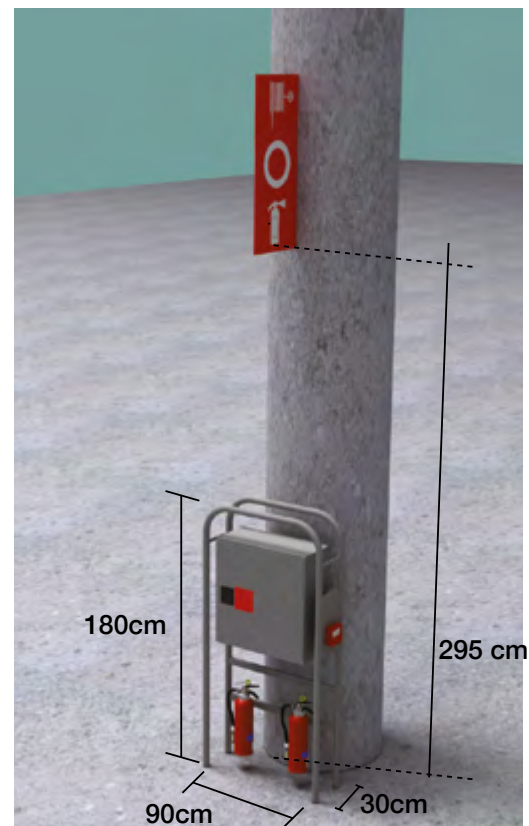
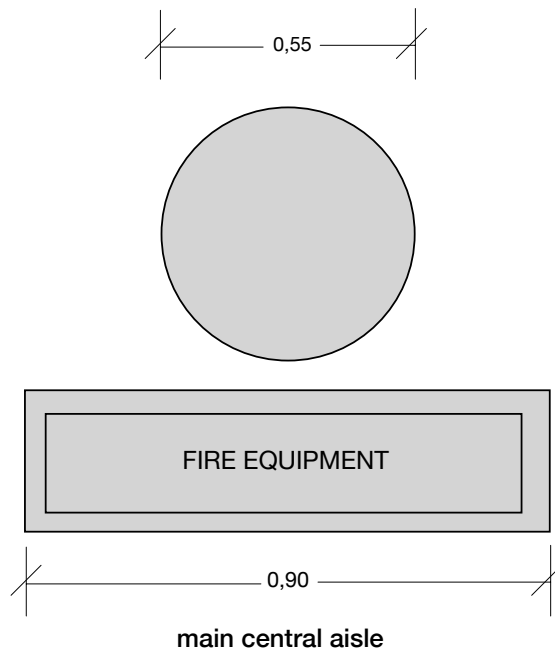

Note that the fire extinguisher equipment and sign need to remain accessible and visible at all times.

Picture

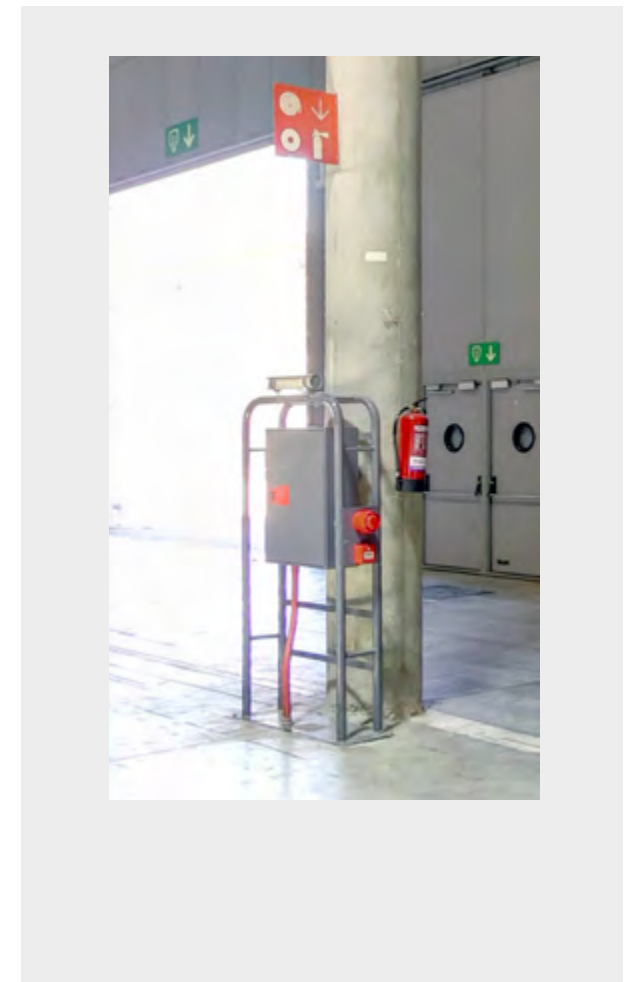

HALL 2 Floorplan

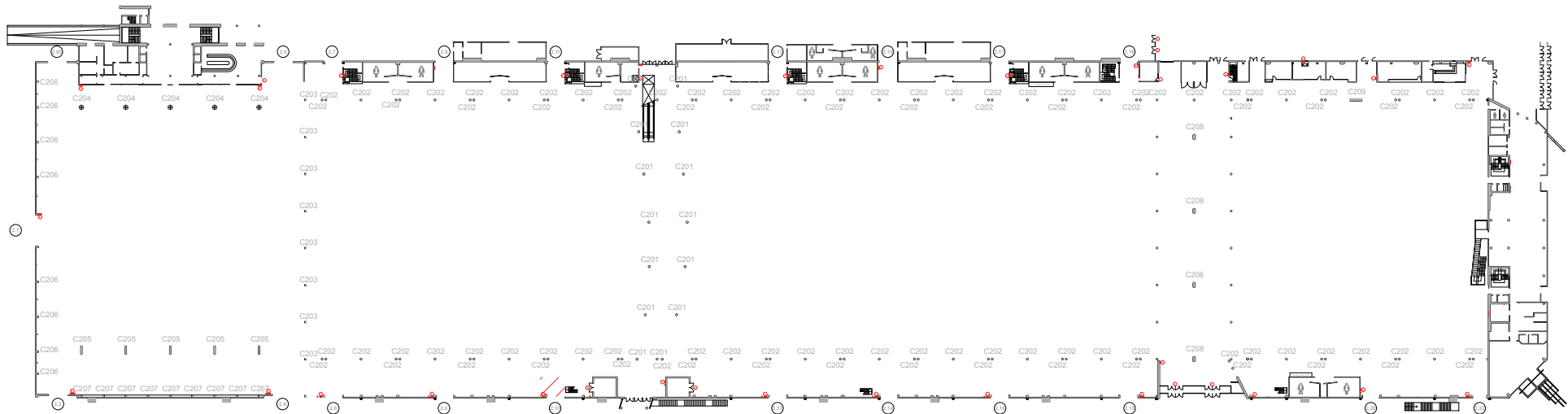

Column details - Gran Via Hall 2

Column type C201

Floorplan & Dimensions

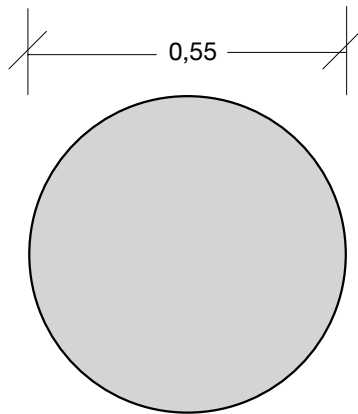

Picture

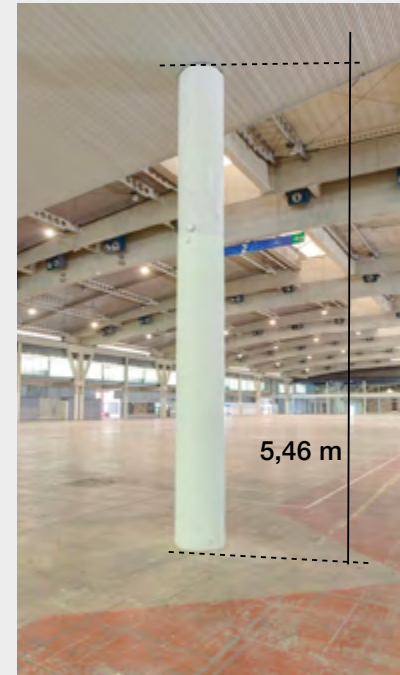

Column details - Gran Via Hall 2

Column type C202

Floorplan & Dimensions

Single

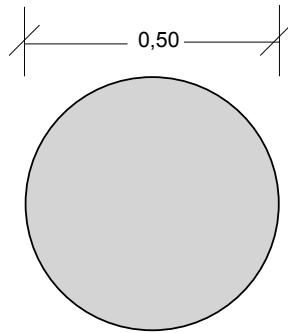

Double

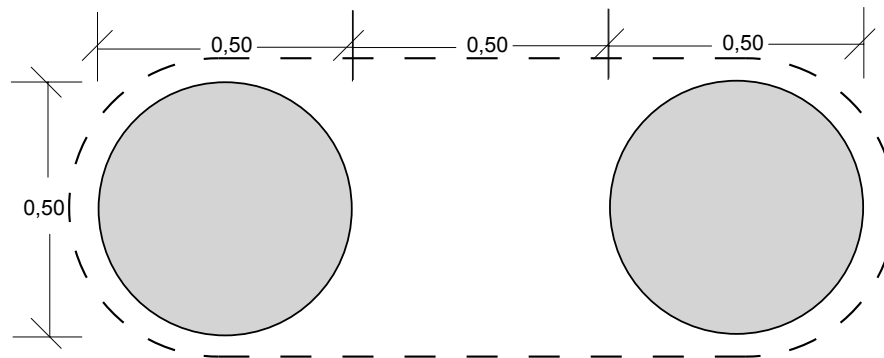

Picture



4,57 m

Column details - Gran Via Hall 2

Column type C203

Floorplan & Dimensions

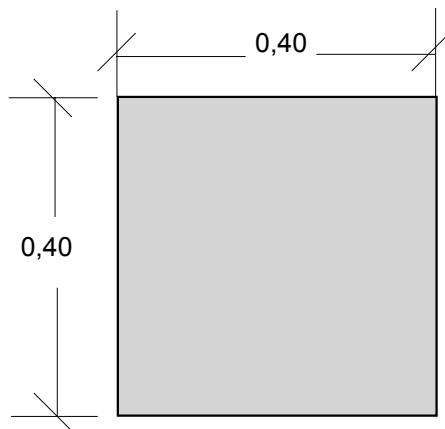

Picture

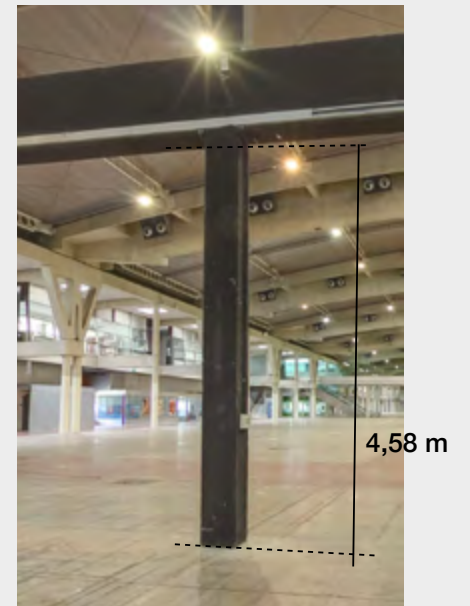

Column details - Gran Via Hall 2

Column type C204

Floorplan & Dimensions

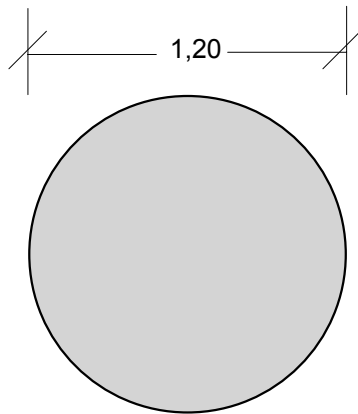

Picture



Column details - Gran Via Hall 2

Column type C205

Floorplan & Dimensions

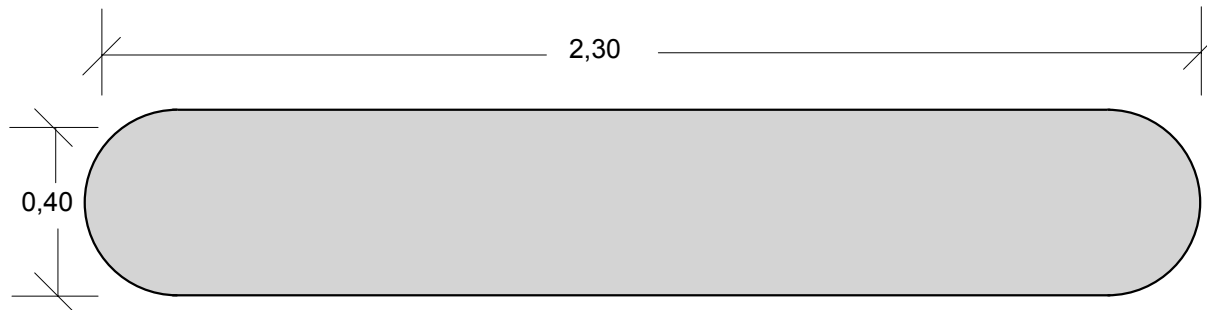

Picture



Column details - Gran Via Hall 2

Column type C206

Floorplan & Dimensions

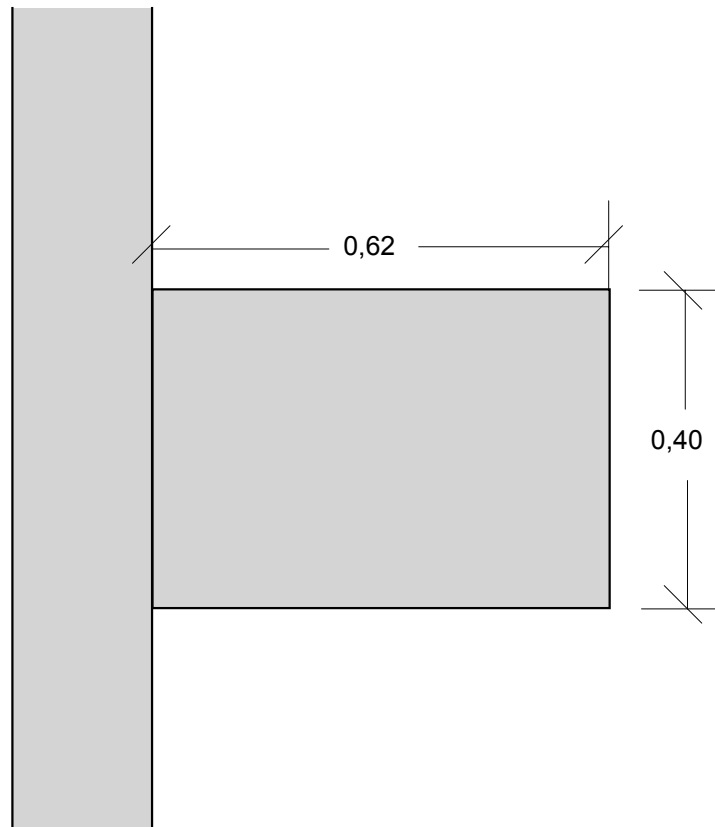

Picture



Column details - Gran Via Hall 2

Column type C207

Floorplan & Dimensions

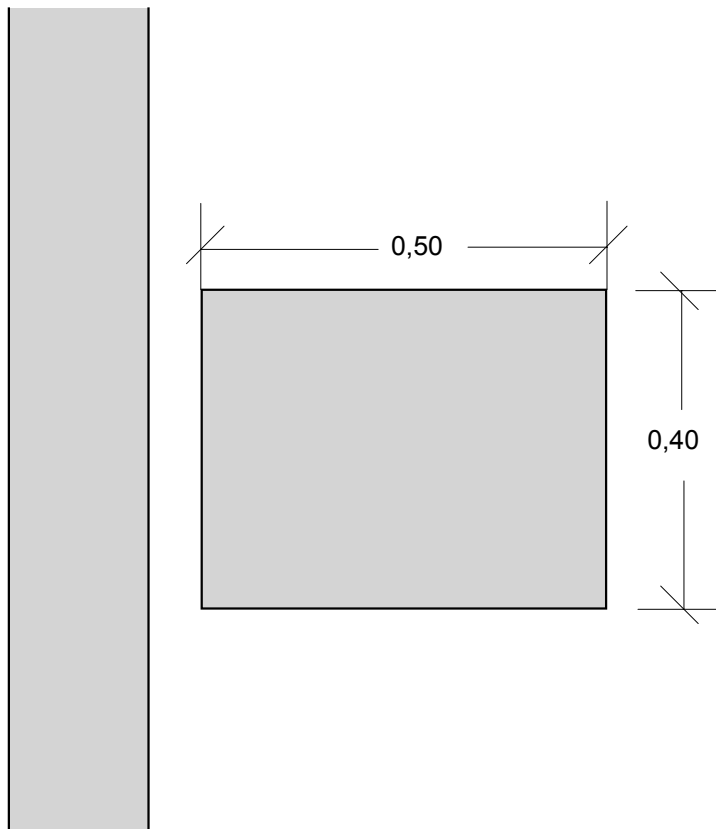

Picture

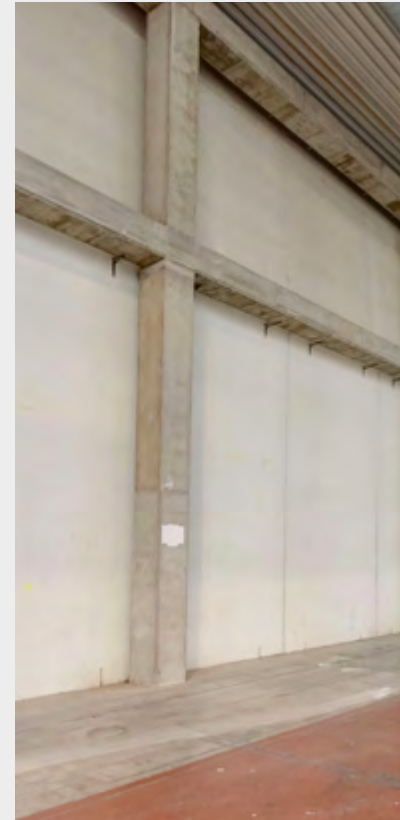

Column details - Gran Via Hall 2

Column type C208

Floorplan & Dimensions

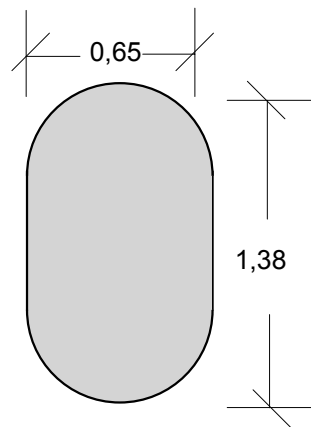

Picture



Column details - Gran Via Hall 2

Column type C209

Floorplan & Dimensions

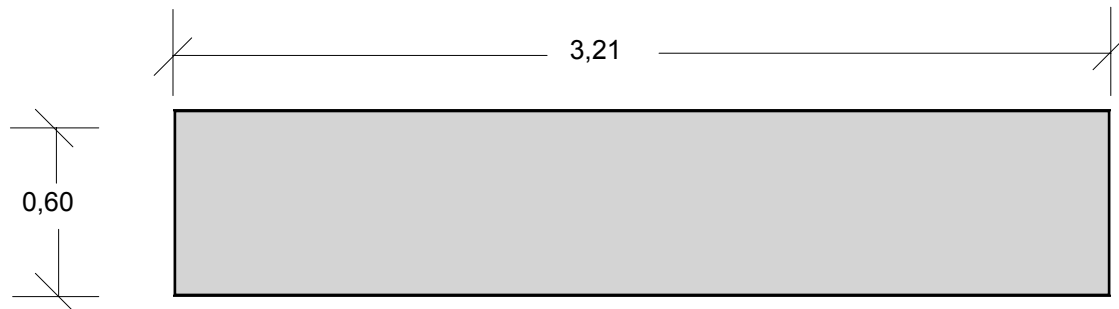

Picture



HALL 3 Floorplan

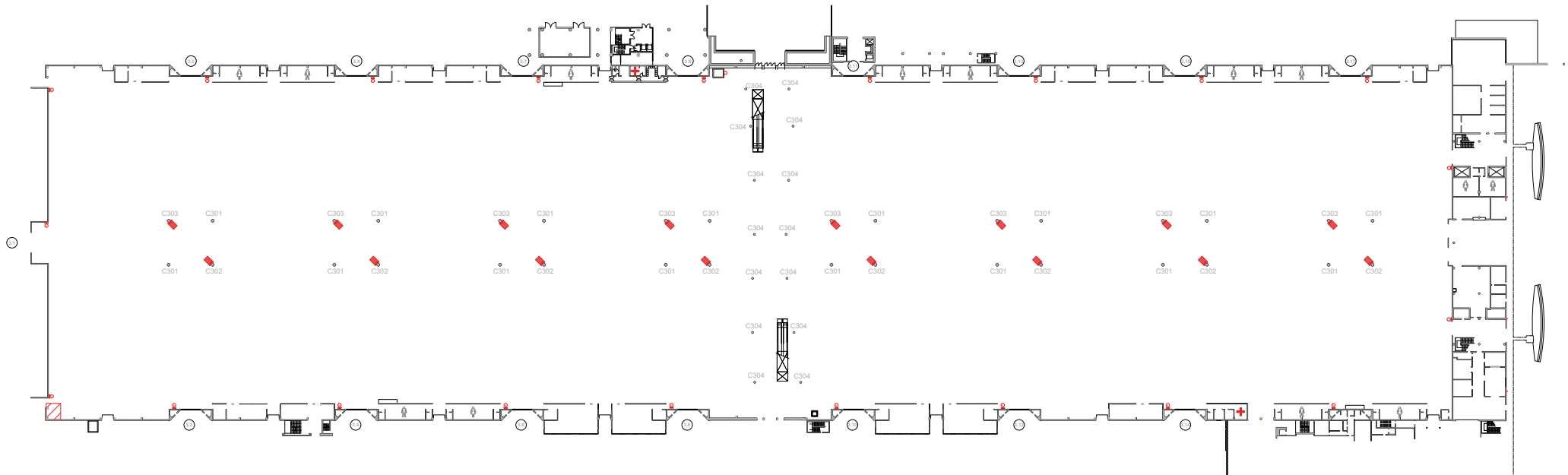

Column details - Gran Via Hall 3

Column type C301

Floorplan & Dimensions

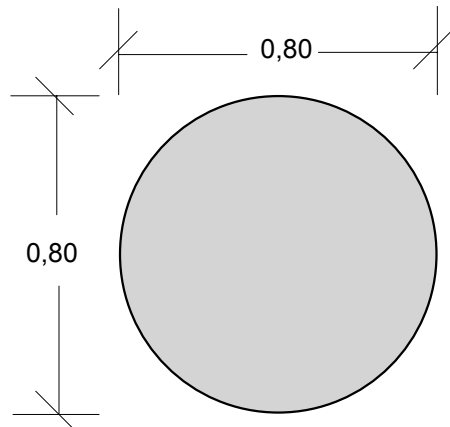

Picture



Column details - Gran Via Hall 3

Column type C302

Floorplan & Dimensions

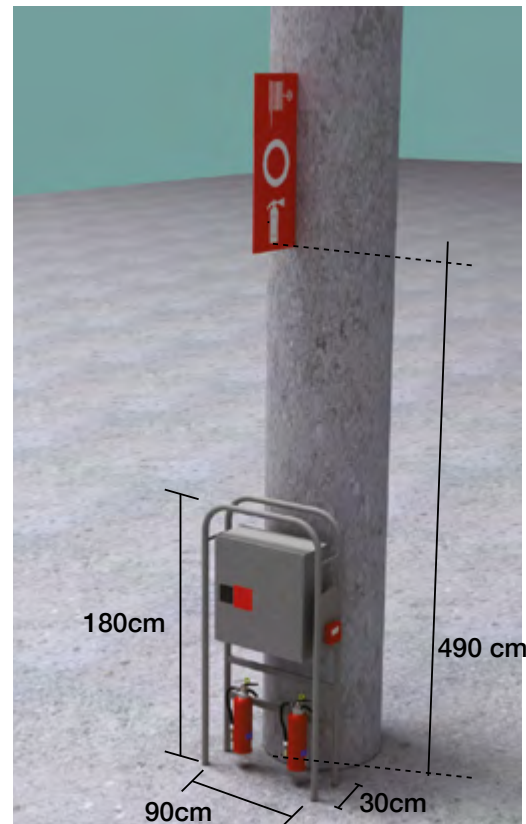
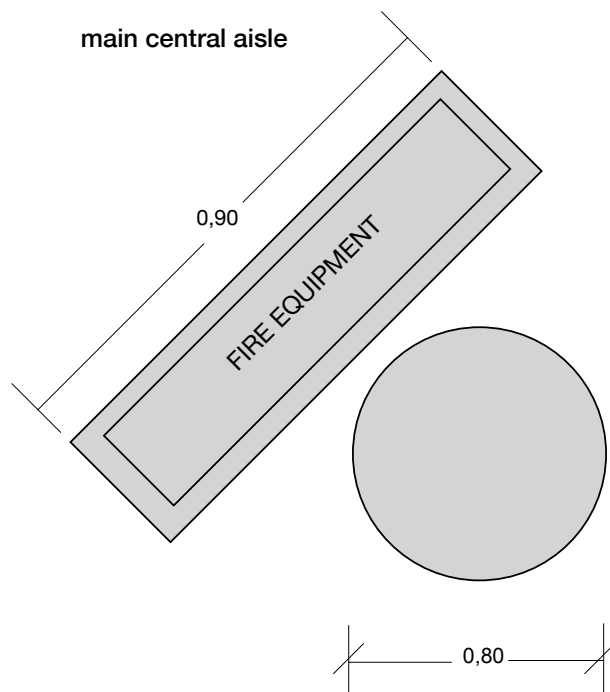

Note that the fire extinguisher equipment and sign need to remain accessible and visible at all times.

Picture

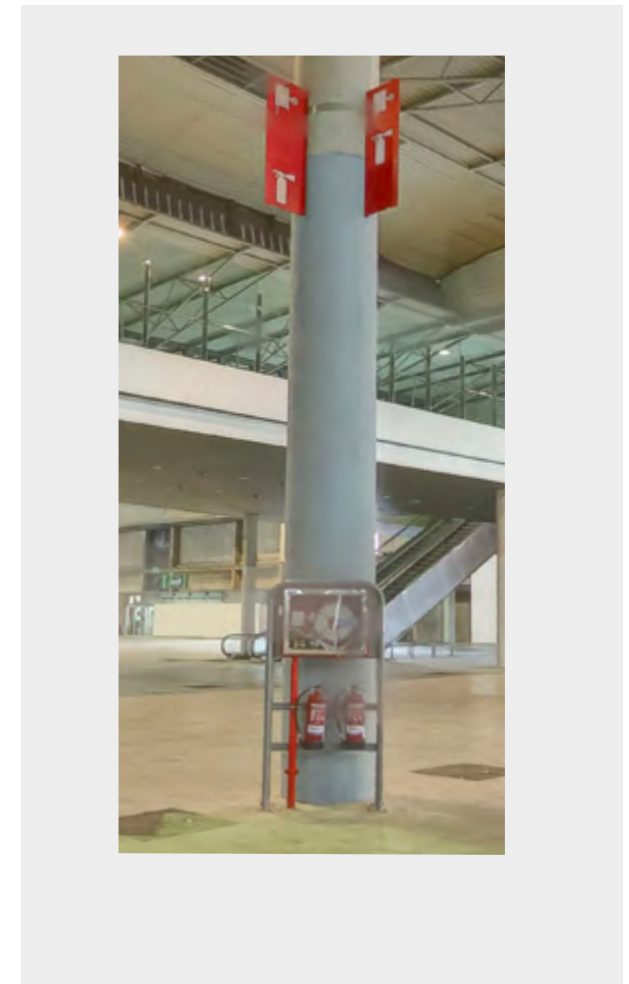

Column details - Gran Via Hall 3

Column type C303

Floorplan & Dimensions

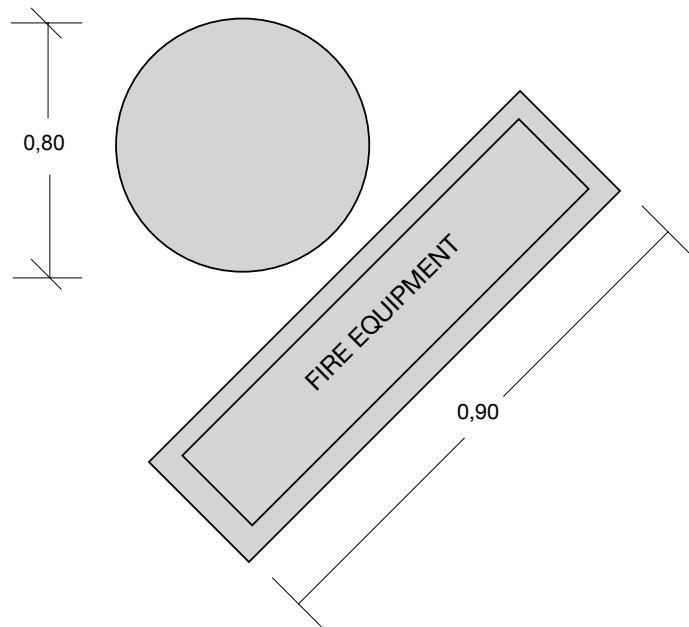

main central aisle

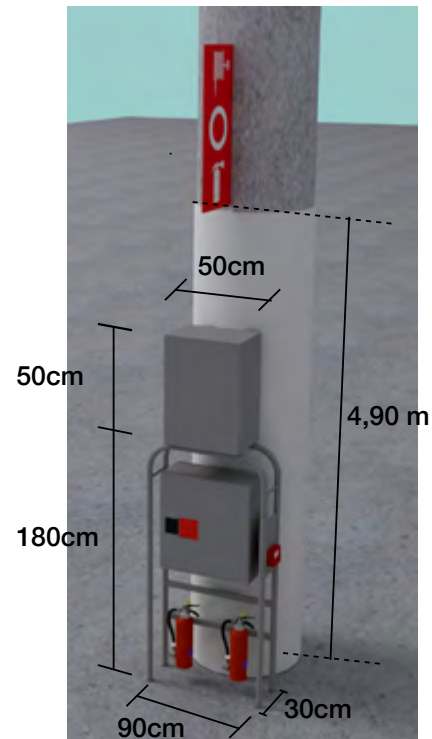

Note that the fire extinguisher equipment and sign need to remain accessible and visible at all times. These columns include a switchboard with 12 schuko type sockets of 10A to be used during build-up only.

Picture

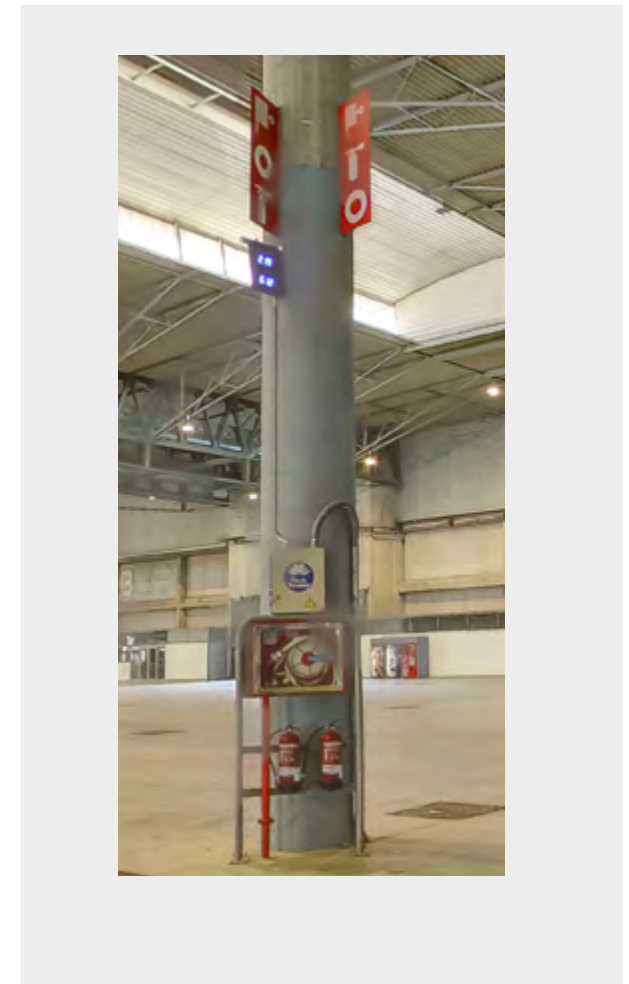

Column details - Gran Via Hall 3

Column type C304

Floorplan & Dimensions

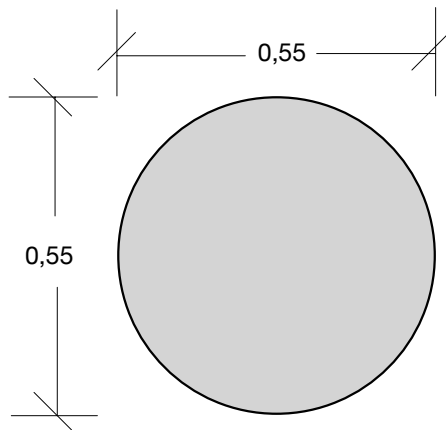

Picture

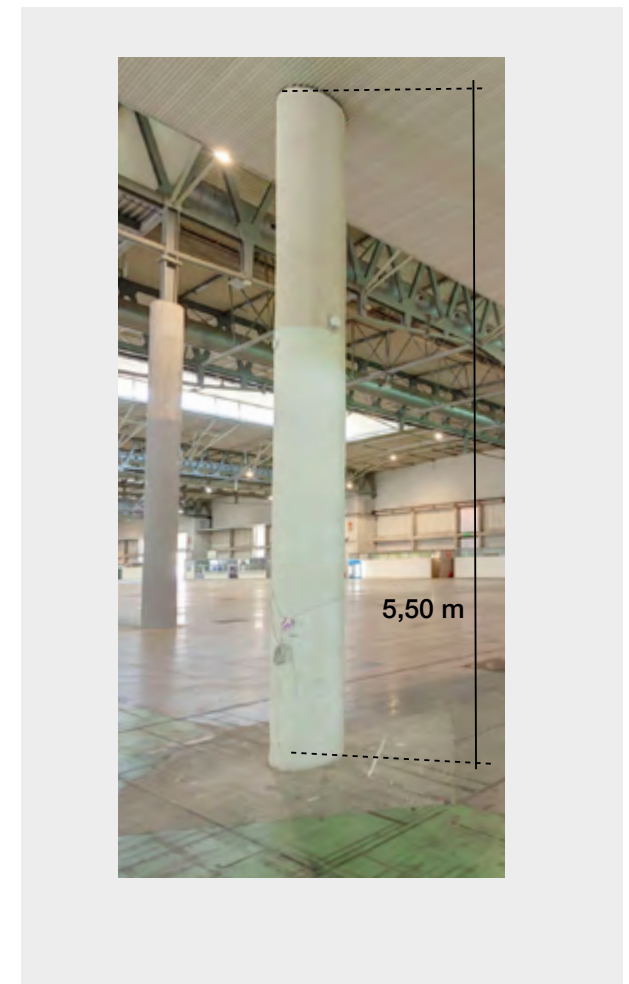

HALL 4 Floorplan

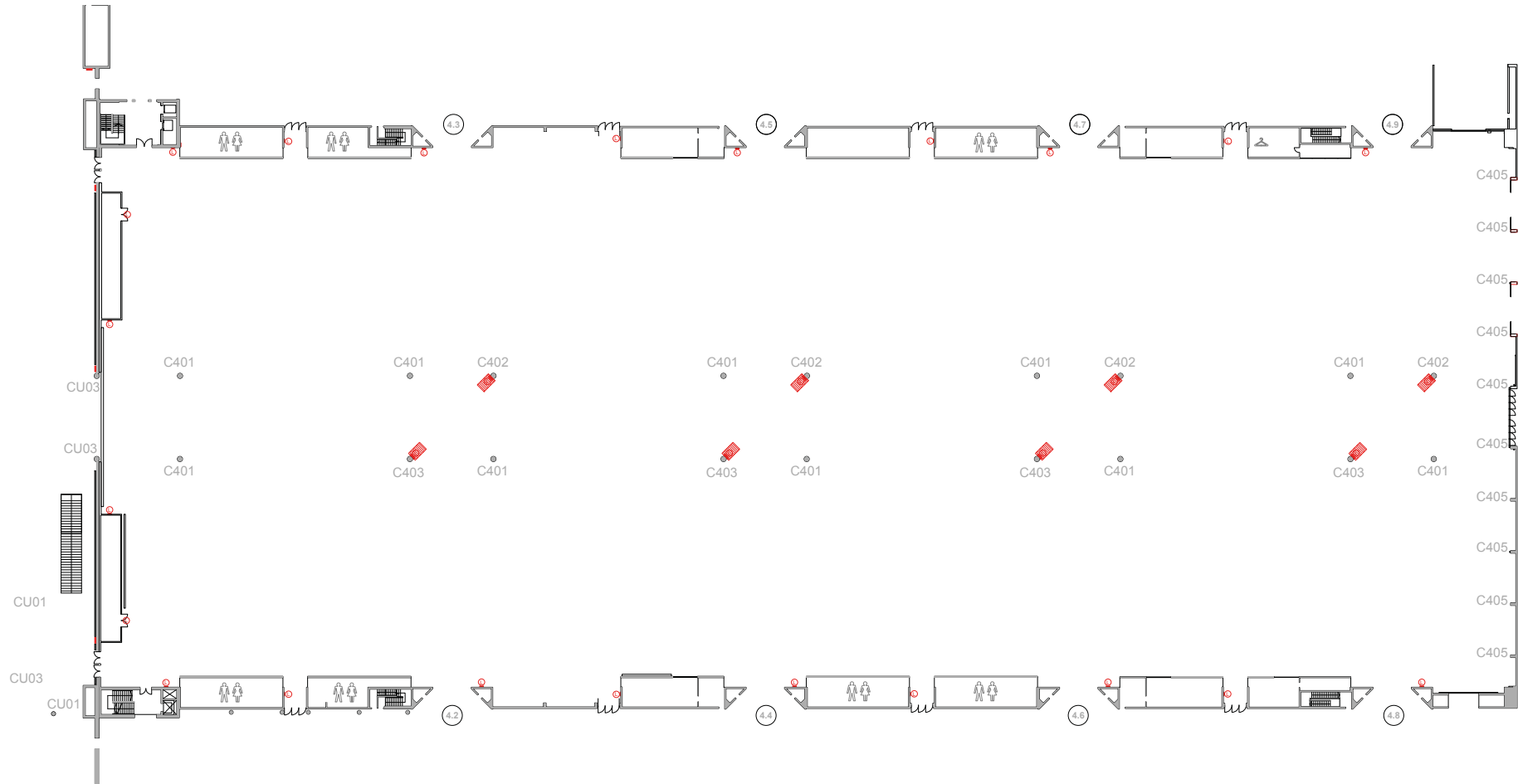

Column details - Gran Via Hall 4

Column type C401

Floorplan & Dimensions

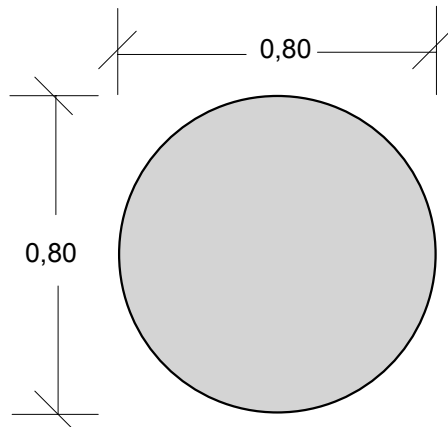

Picture



Column details - Gran Via Hall 4

Column type C402

Floorplan & Dimensions

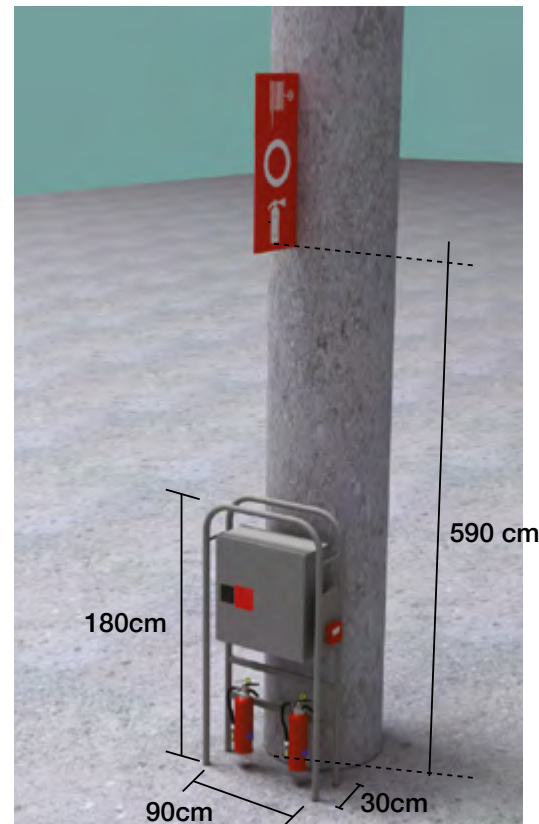
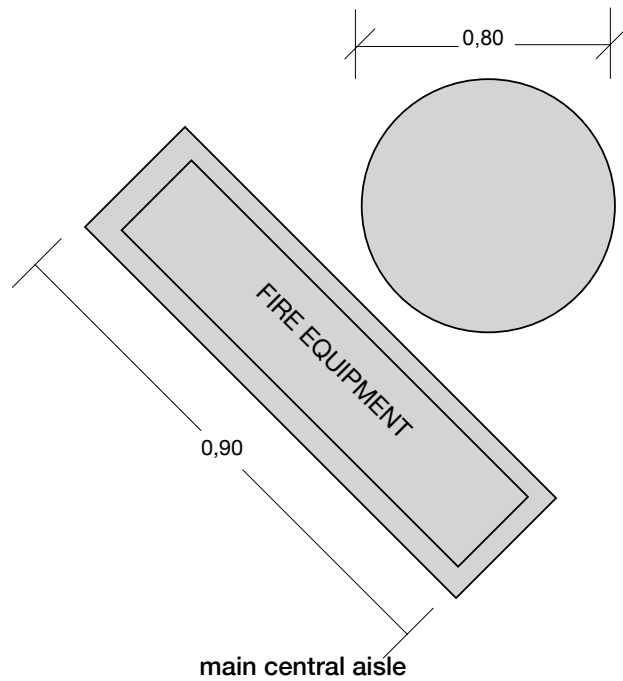

Note that the fire extinguisher equipment and sign need to remain accessible and visible at all times.

Picture



Column details - Gran Via Hall 4

Column type C403

Floorplan & Dimensions

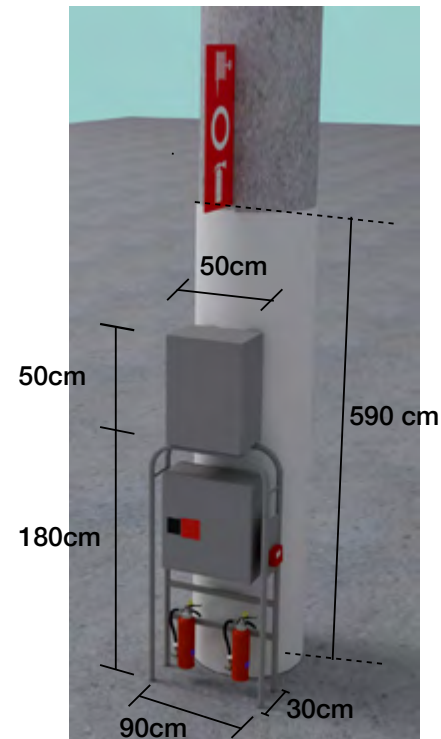
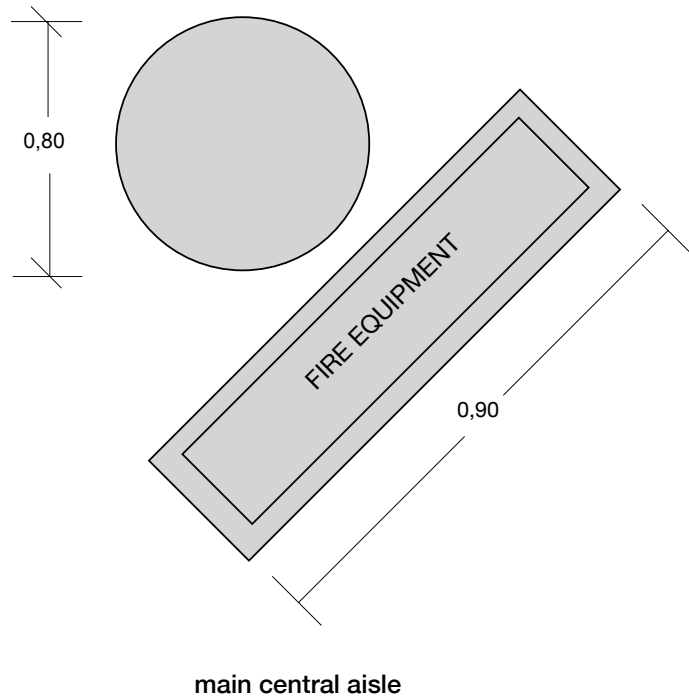

Note that the fire extinguisher equipment and sign need to remain accessible and visible at all times. These columns include a switchboard with 12 schuko type sockets of 10A to be used during build-up only.

Picture



HALL 5 Floorplan

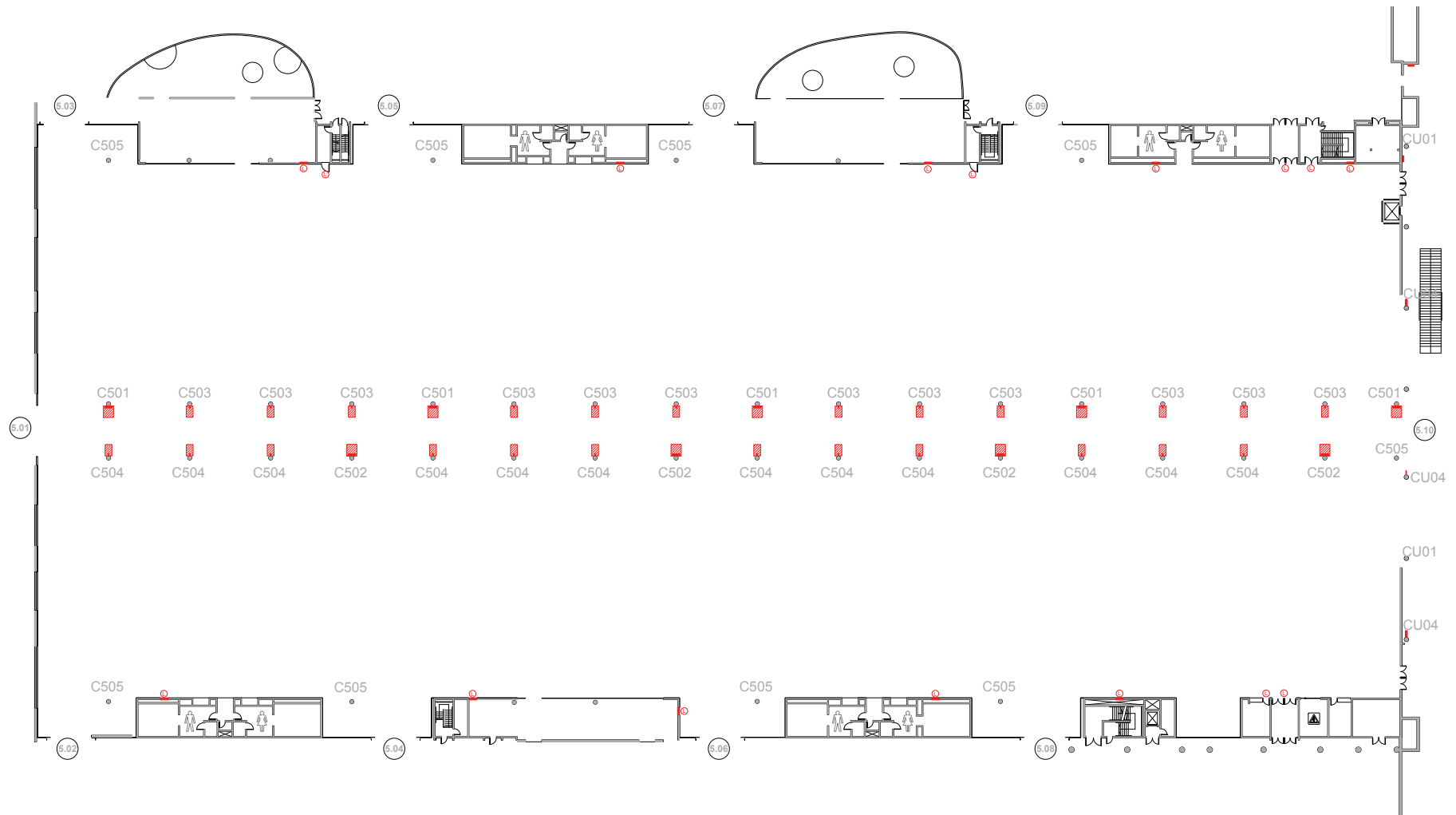

Column details - Gran Via Hall 5

Column type C501

Floorplan & Dimensions

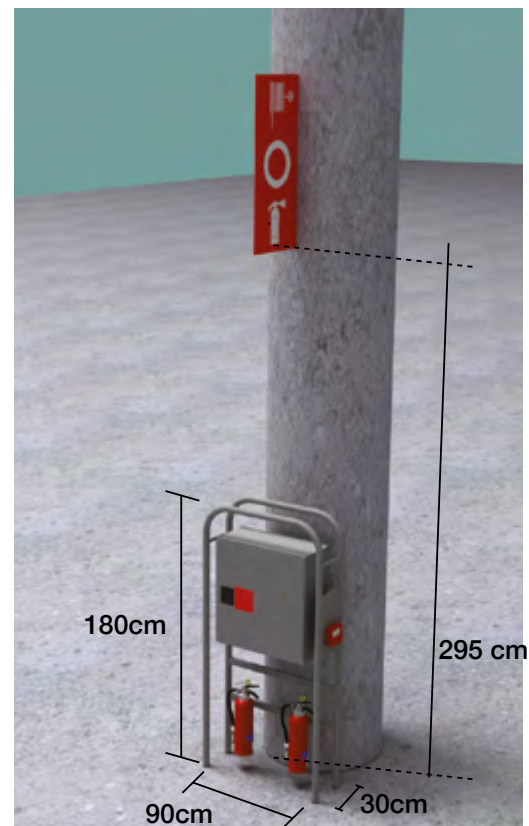
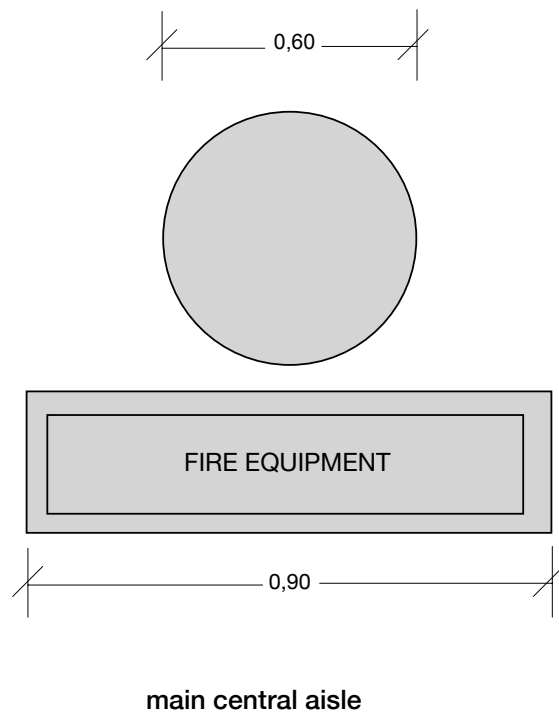

Note that the fire extinguisher equipment and sign need to remain accessible and visible at all times.

Picture

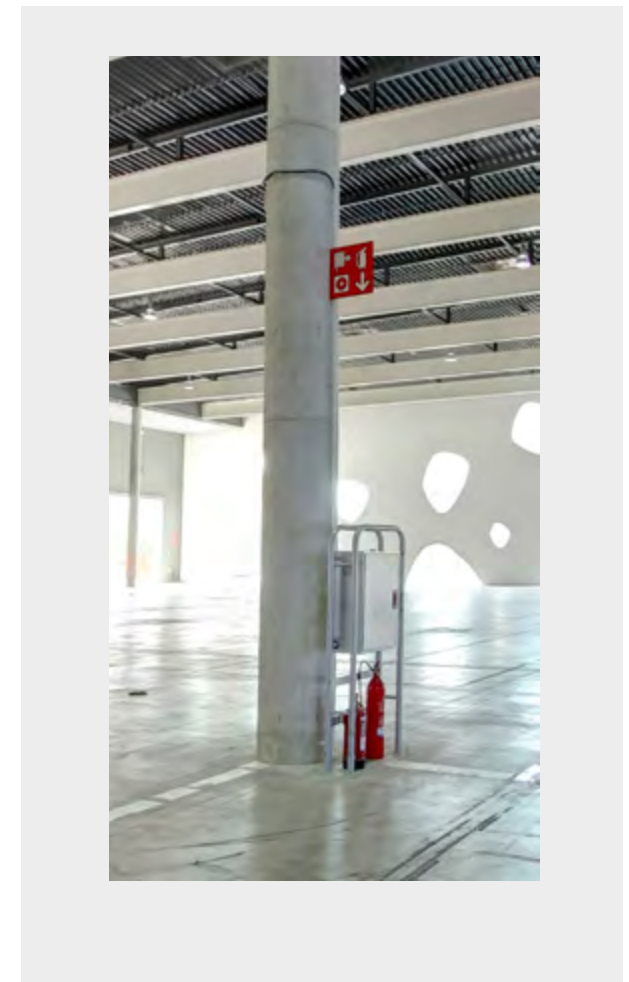

Column details - Gran Via Hall 5

Column type C502

Floorplan & Dimensions

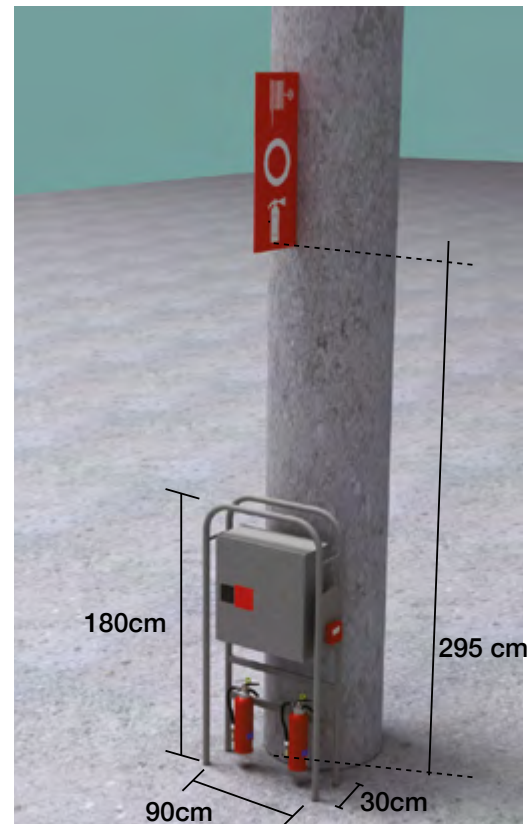
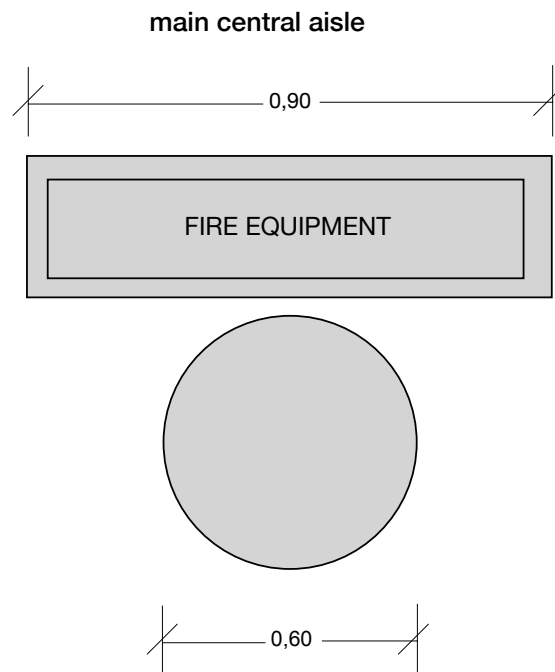

Note that the fire extinguisher equipment and sign need to remain accessible and visible at all times.

Picture

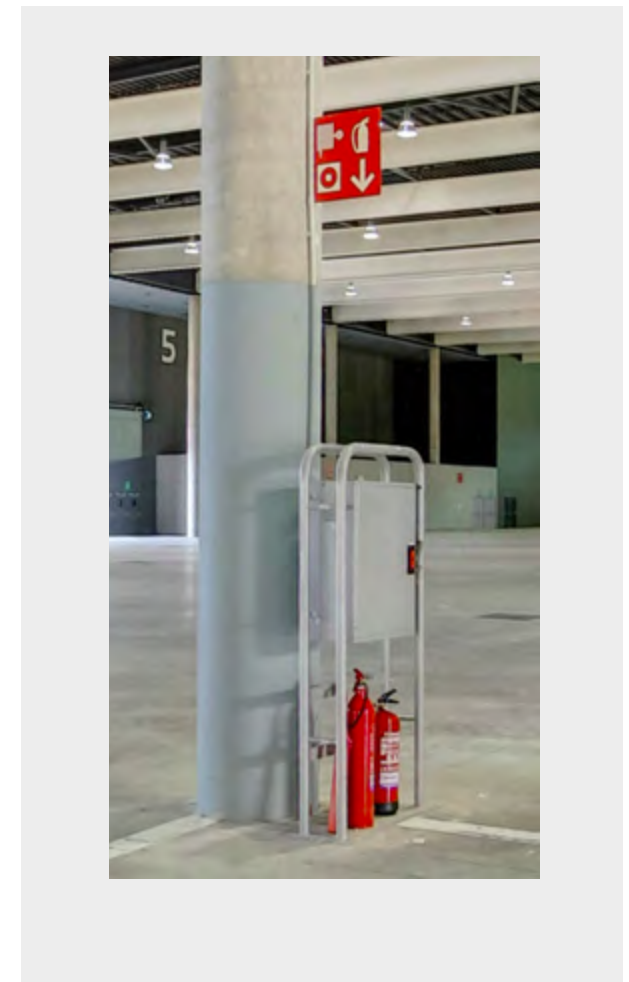

Column details - Gran Via Hall 5

Column type C503

Floorplan & Dimensions

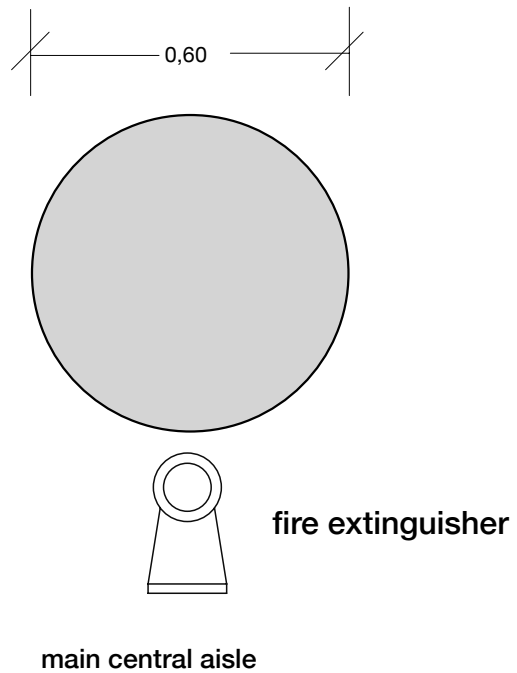

Picture

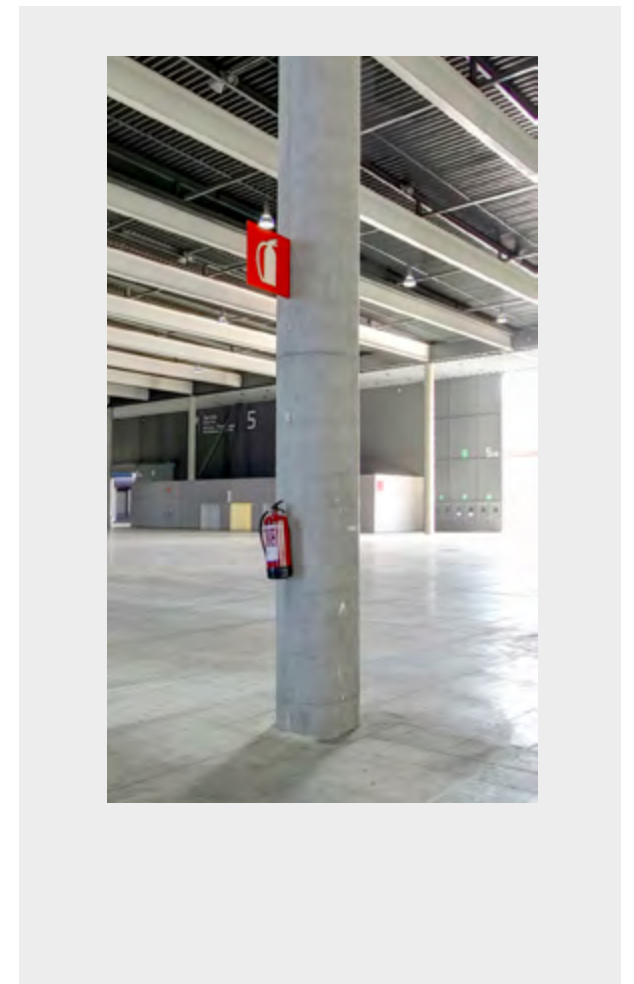

Column details - Gran Via Hall 5

Column type C504

Floorplan & Dimensions

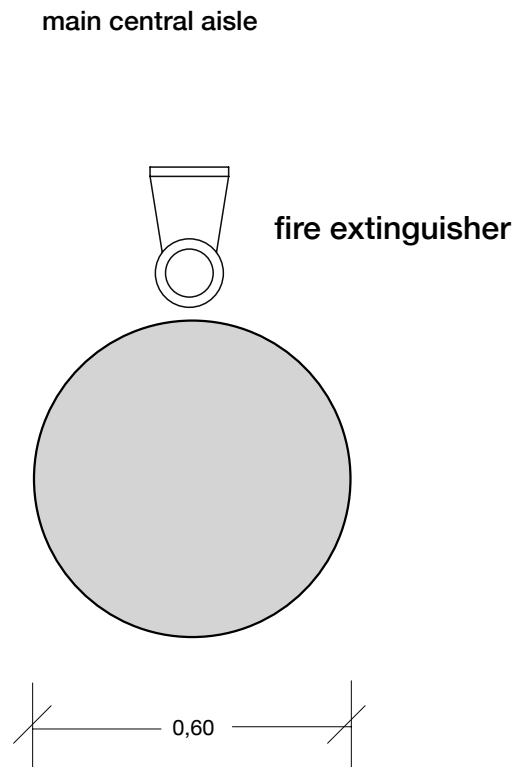

Picture

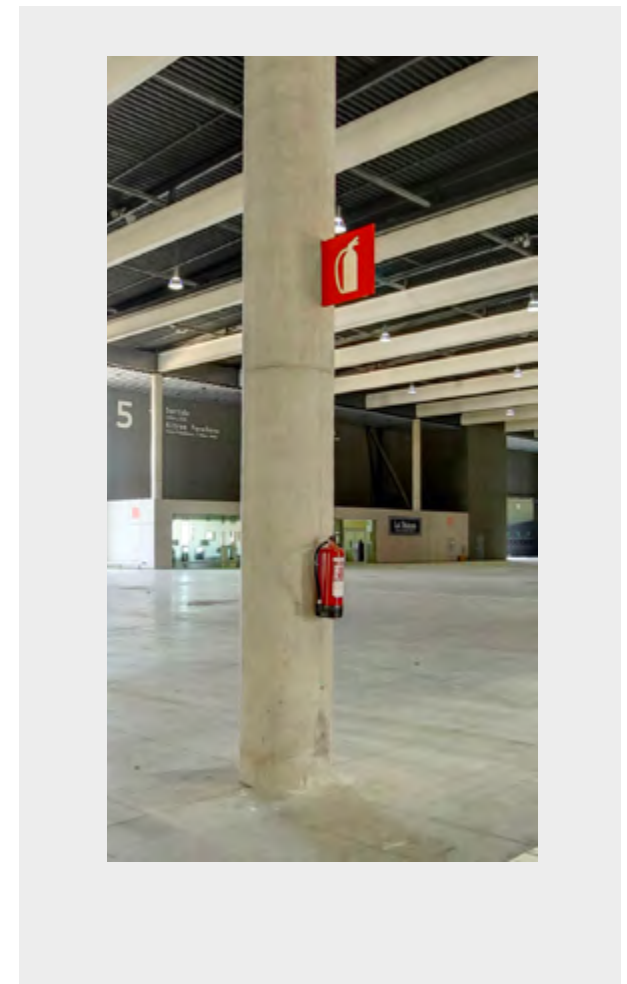

Column details - Gran Via Hall 5

Column type C505

Floorplan & Dimensions

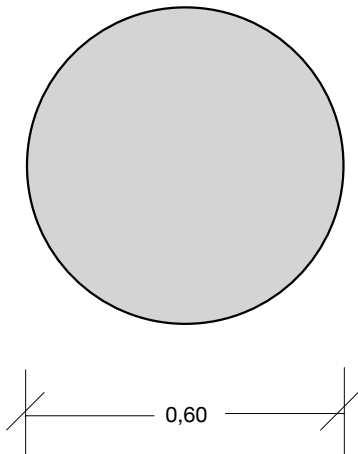

Picture

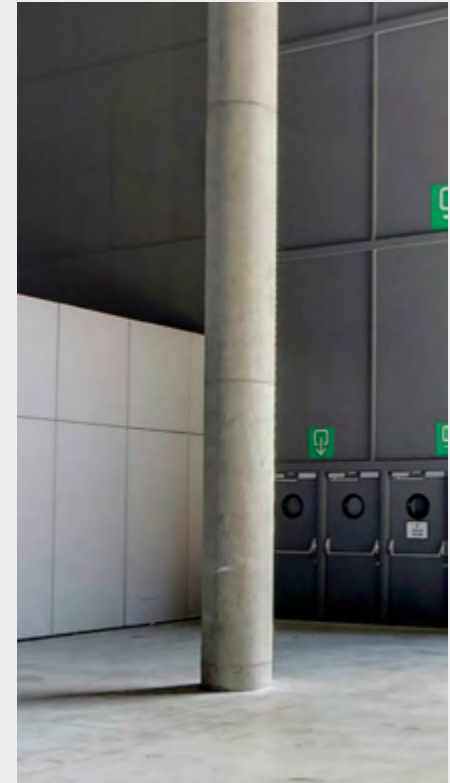

HALL 6 Floorplan

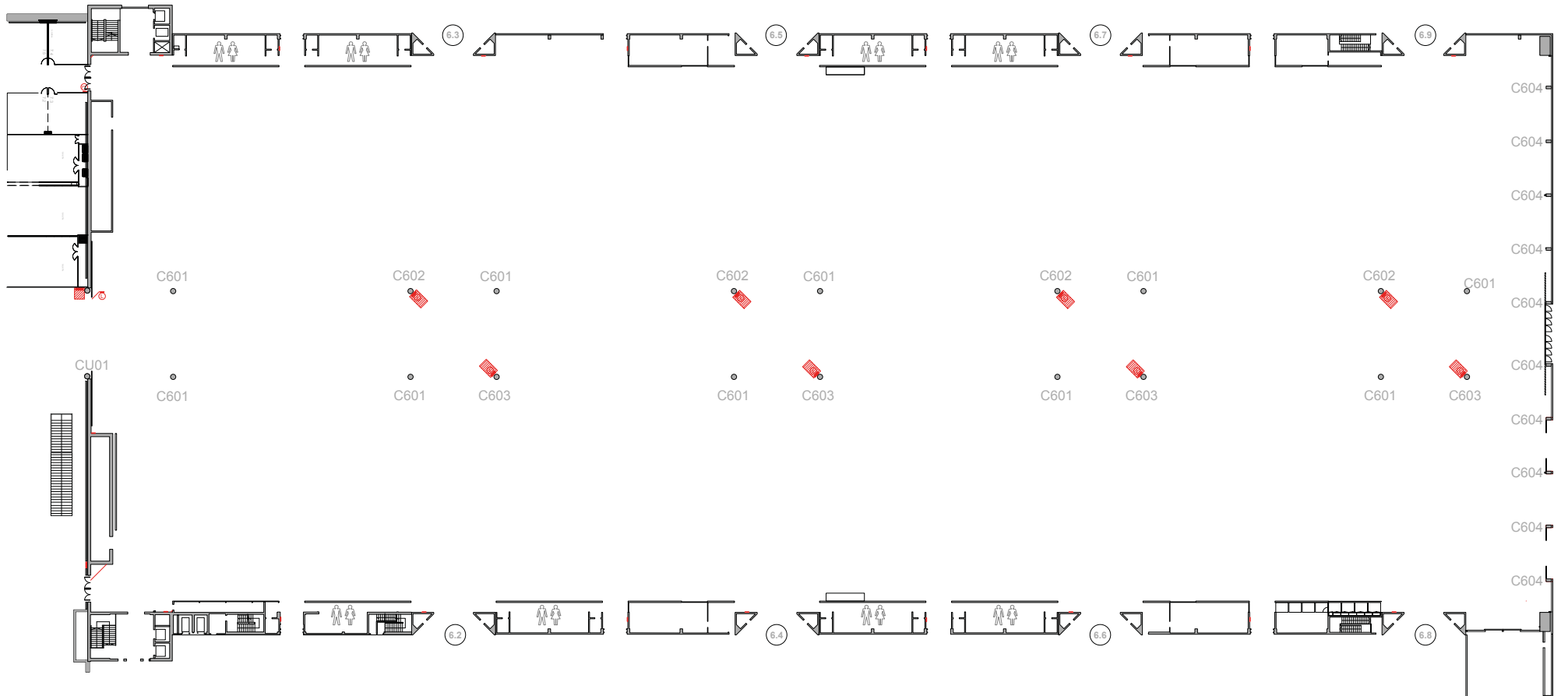

Column details - Gran Via Hall 6

Column type C601

Floorplan & Dimensions

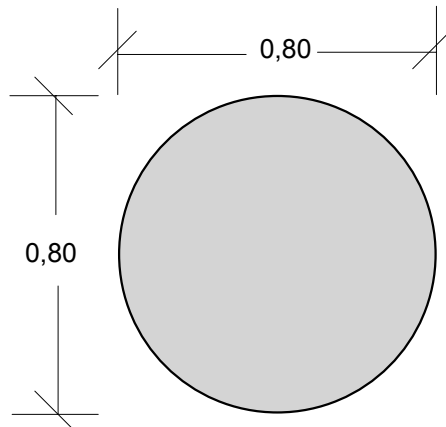

Picture



Column details - Gran Via Hall 6

Column type C602

Floorplan & Dimensions

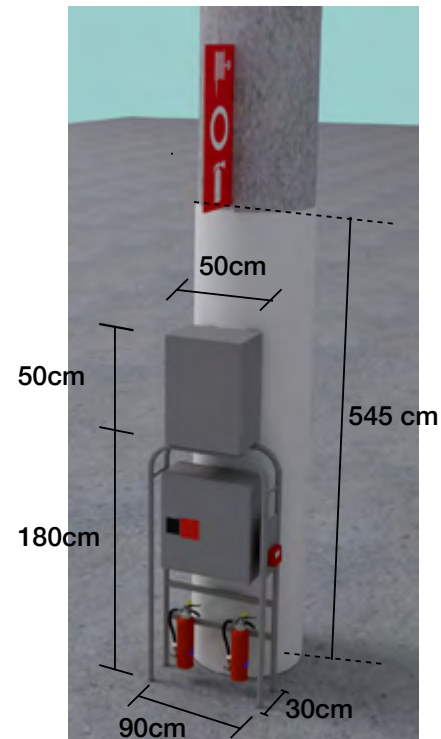
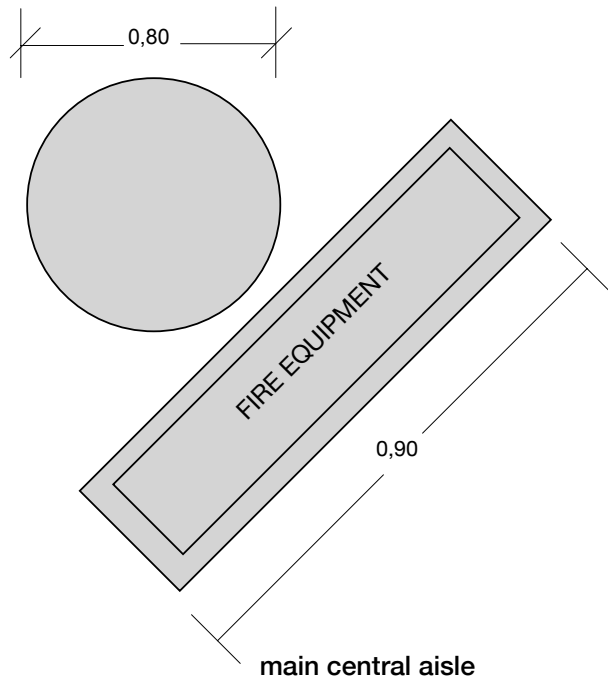

Note that the fire extinguisher equipment and sign need to remain accessible and visible at all times. These columns include a switchboard with 12 schuko type sockets of 10A to be used during build-up only.

Picture



Column details - Gran Via Hall 6

Column type C603

Floorplan & Dimensions

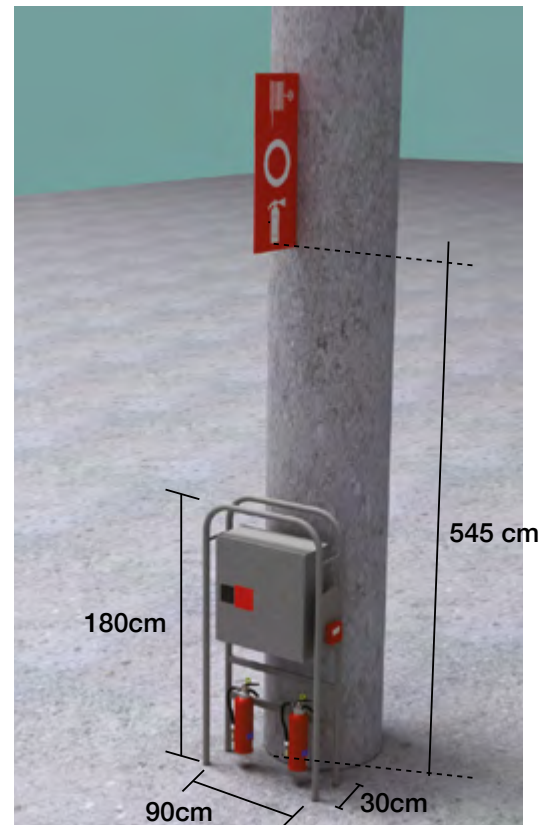
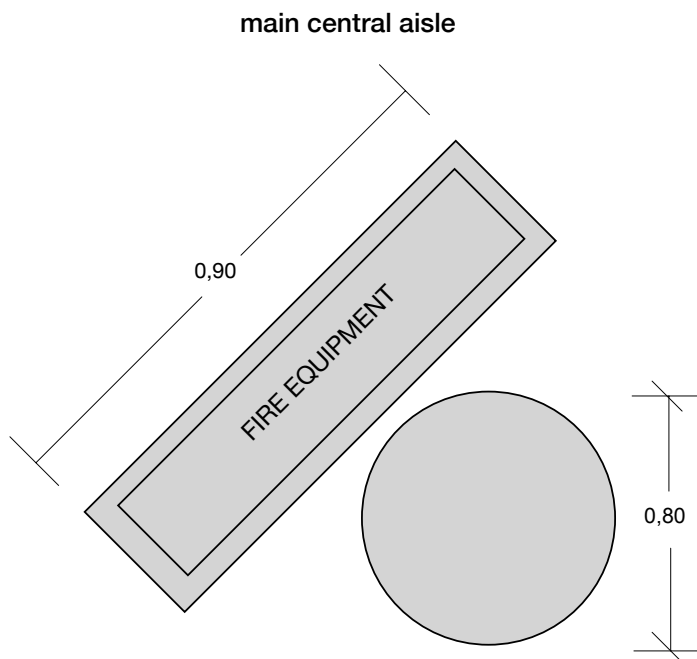

Note that the fire extinguisher equipment and sign need to remain accessible and visible at all times.

Picture



Column details - Gran Via Hall 6

Column type C604

Floorplan & Dimensions

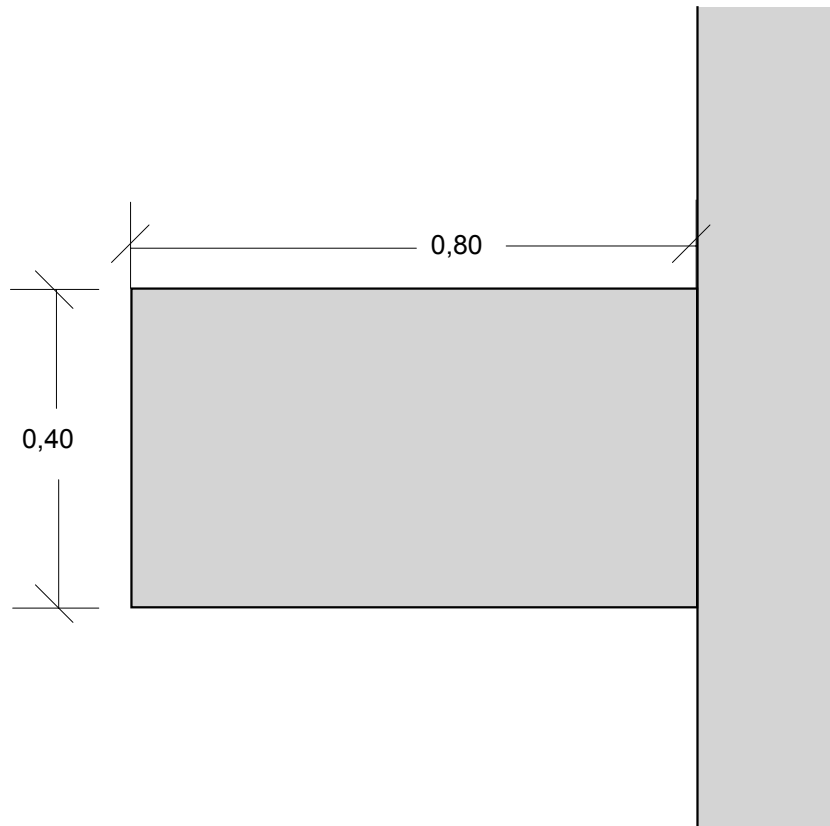

Picture

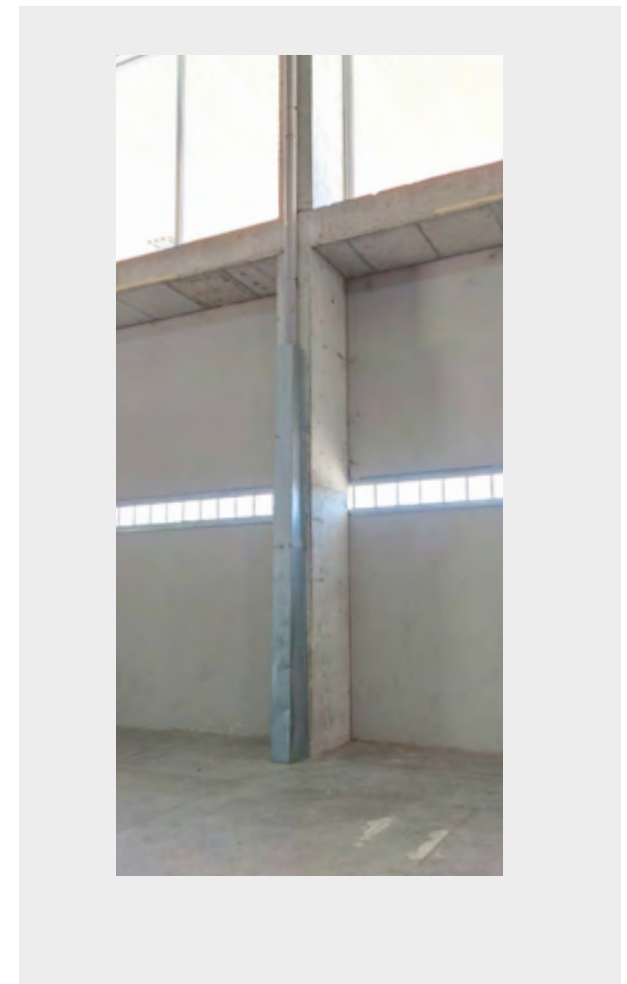

HALL 7 Floorplan

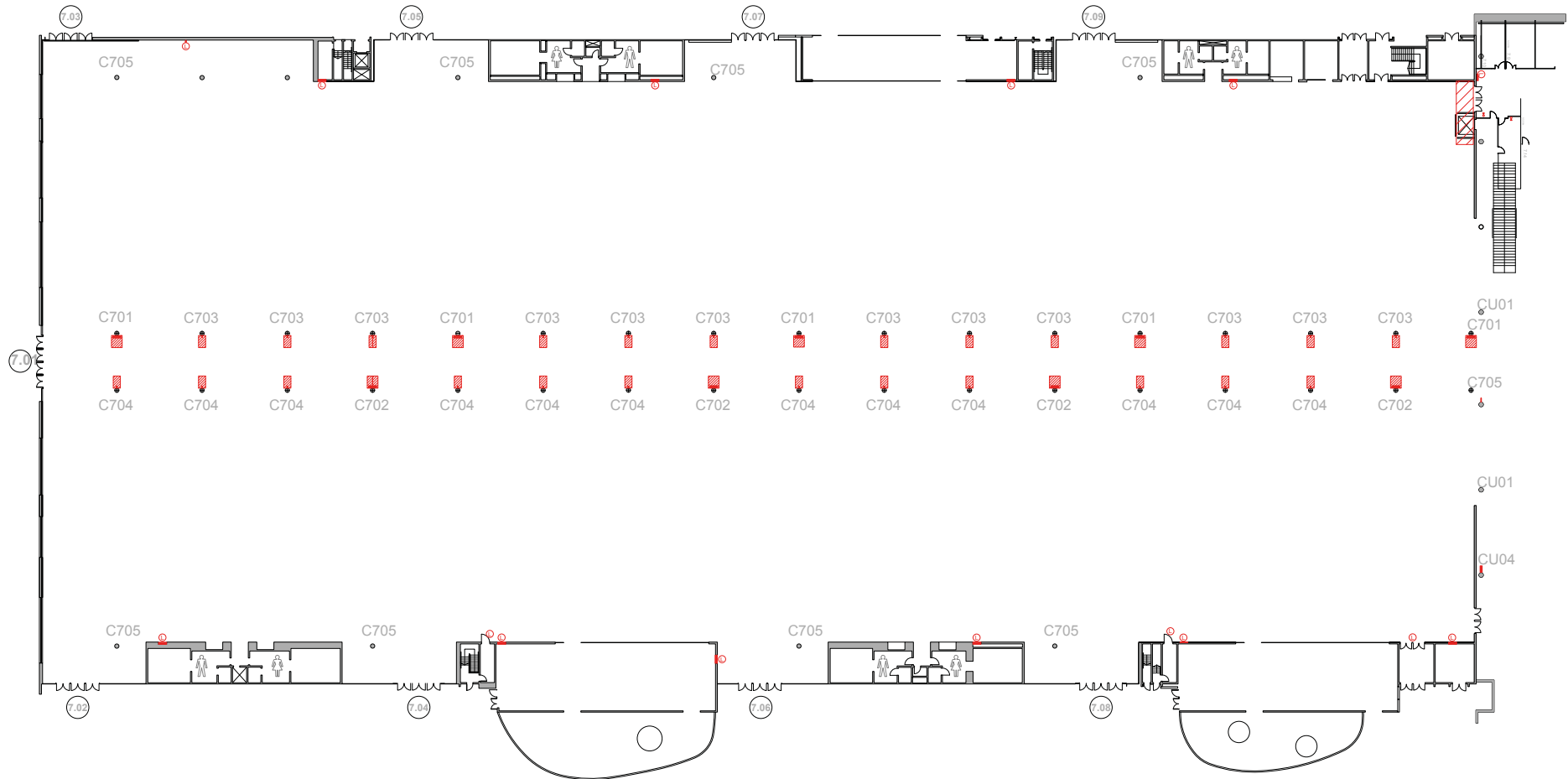

Column details - Gran Via Hall 7

Column type C701

Floorplan & Dimensions

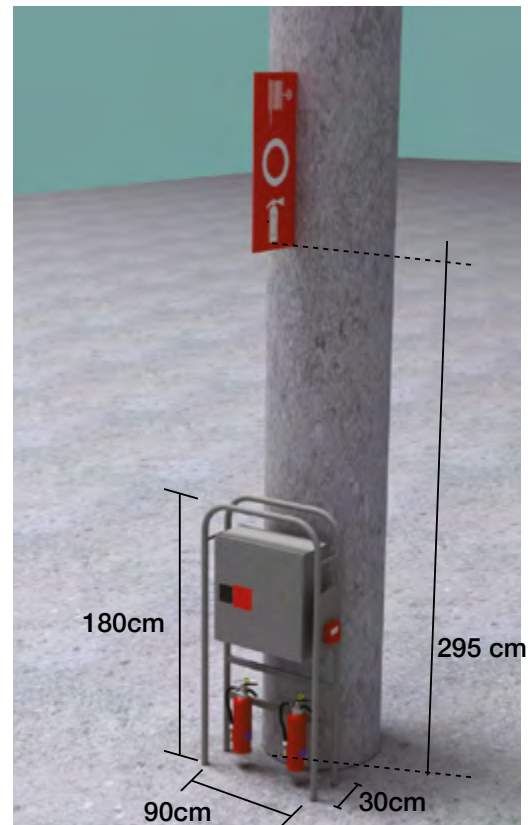
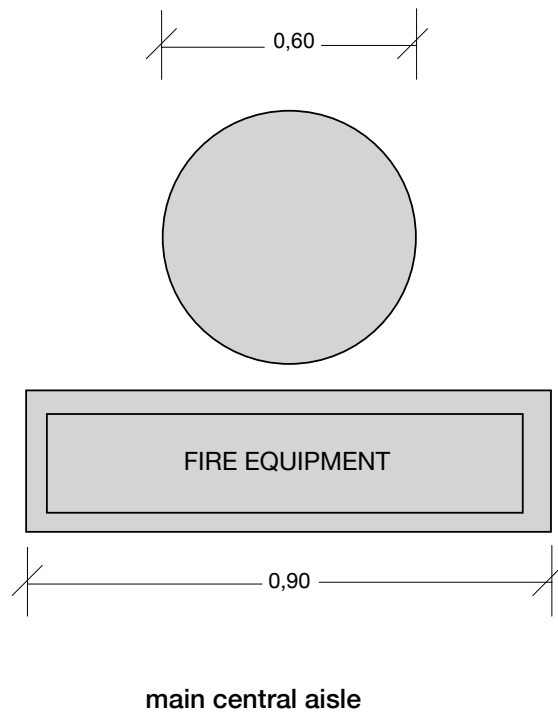

Note that the fire extinguisher equipment and sign need to remain accessible and visible at all times.

Picture

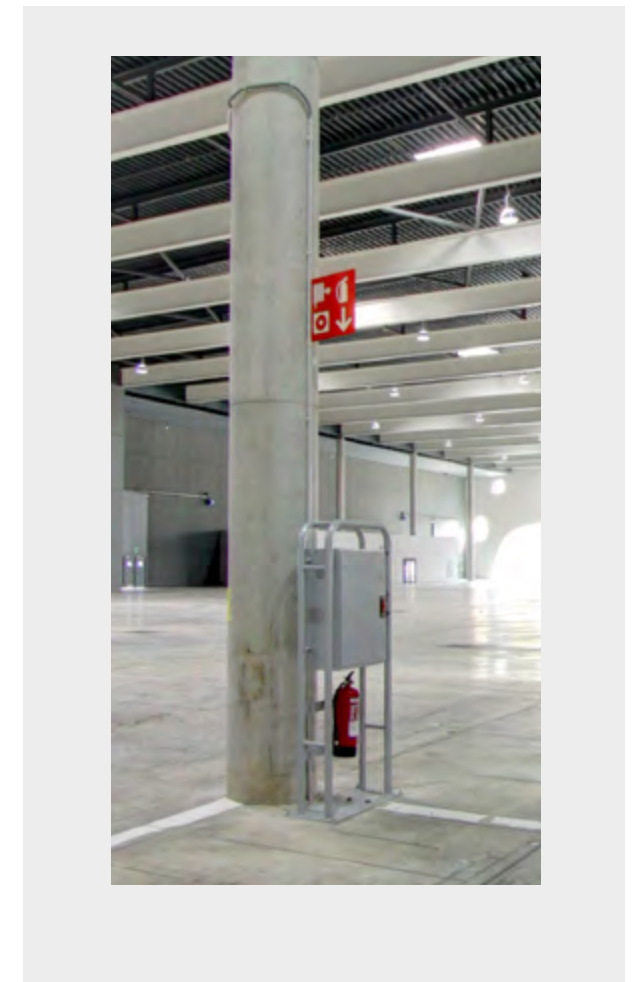

Column details - Gran Via Hall 7

Column type C702

Floorplan & Dimensions

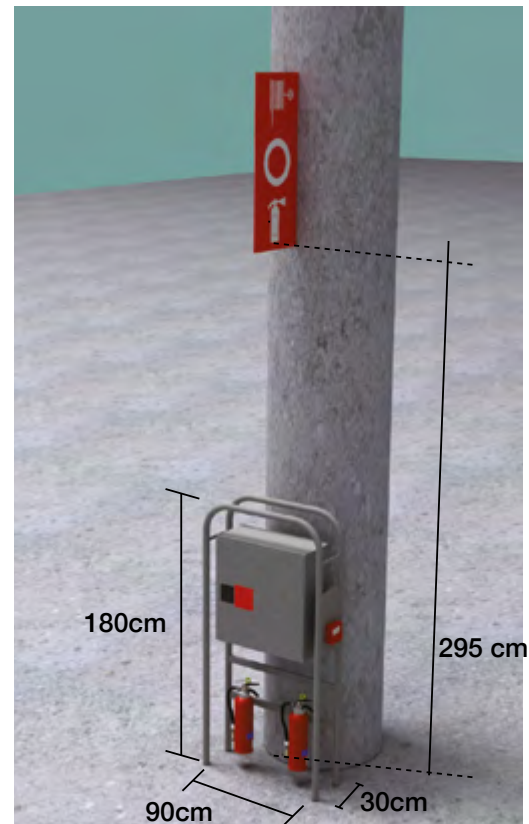
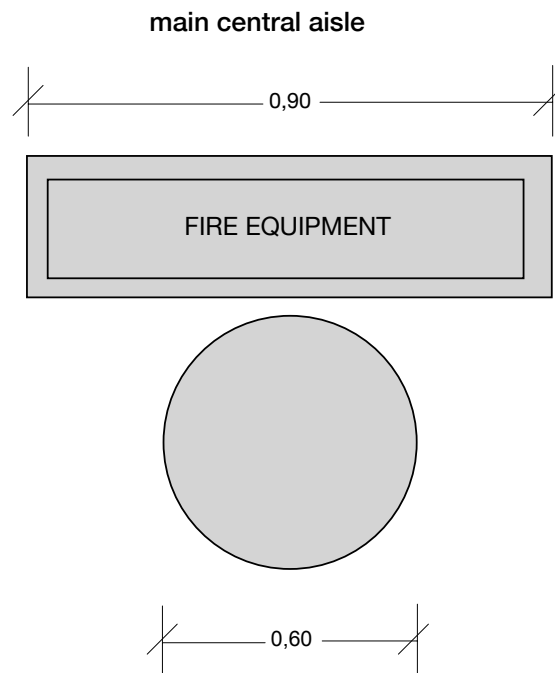

Note that the fire extinguisher equipment and sign need to remain accessible and visible at all times.

Picture

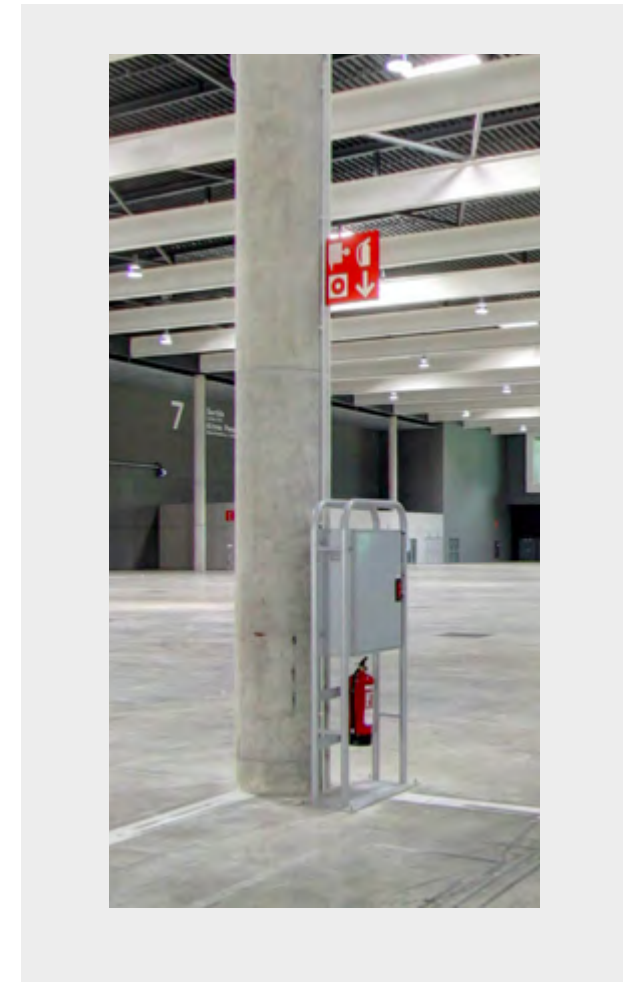

Column details - Gran Via Hall 7

Column type C703

Floorplan & Dimensions

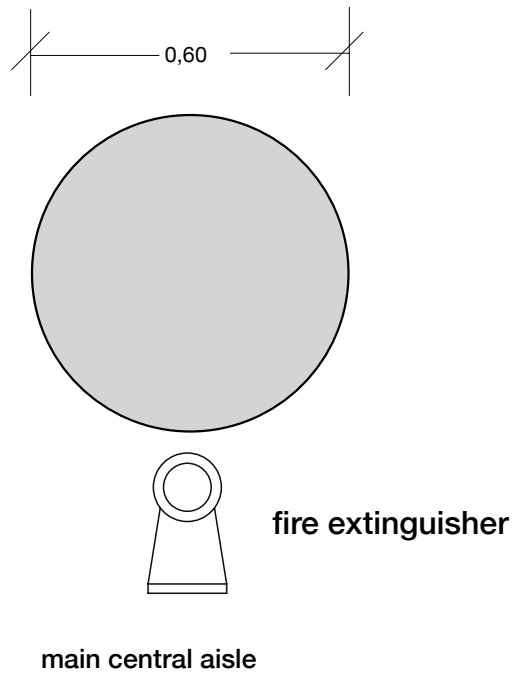

Picture

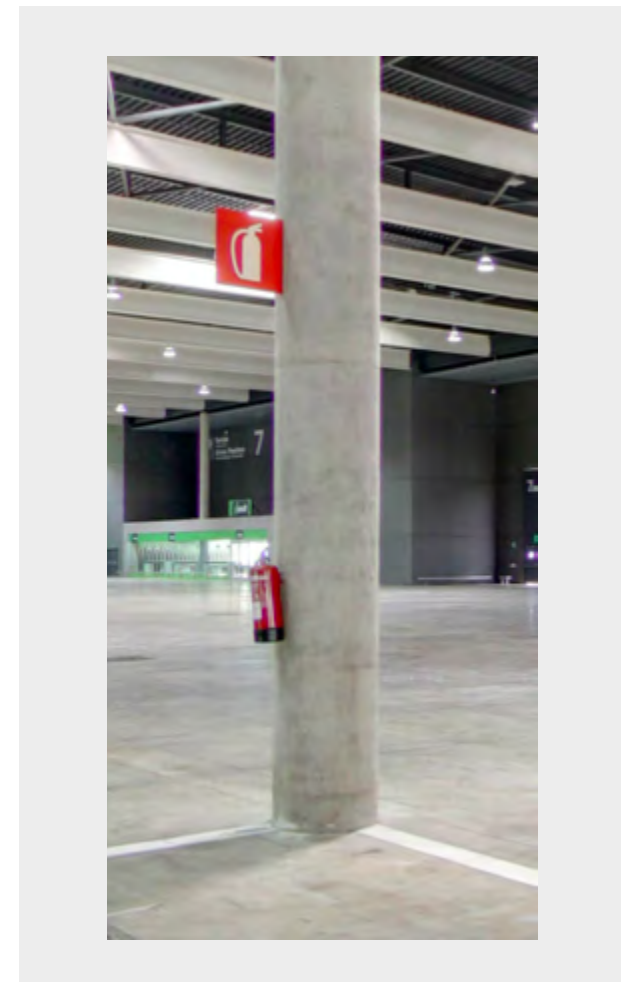

Column details - Gran Via Hall 7

Column type C704

Floorplan & Dimensions

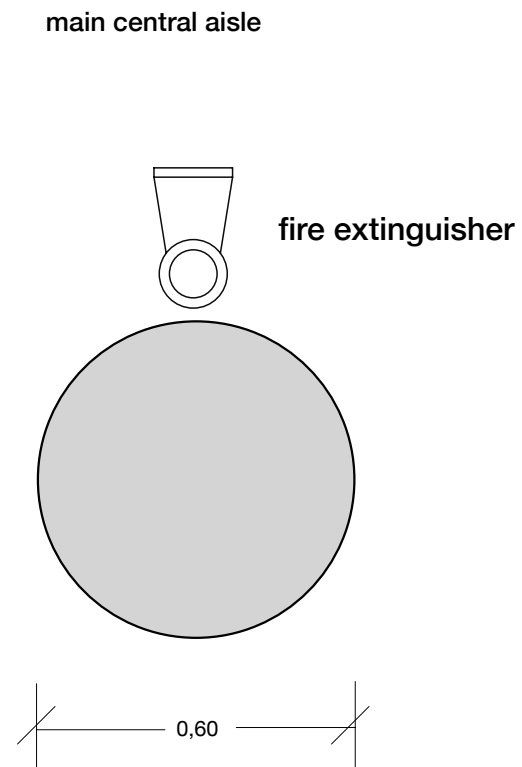

Picture

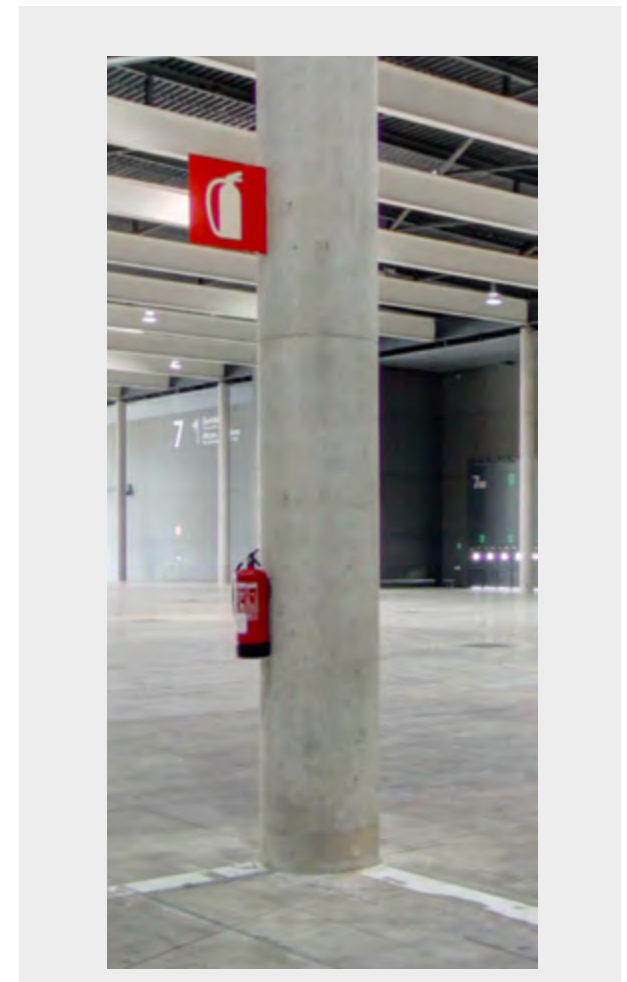

Column details - Gran Via Hall 7

Column type C705

Floorplan & Dimensions

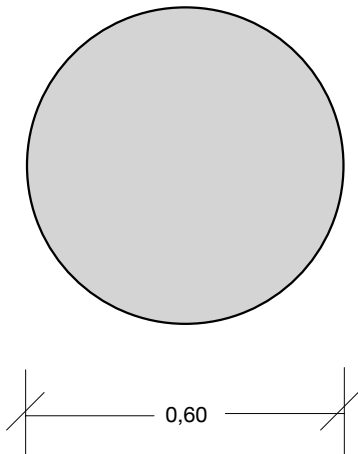

Picture

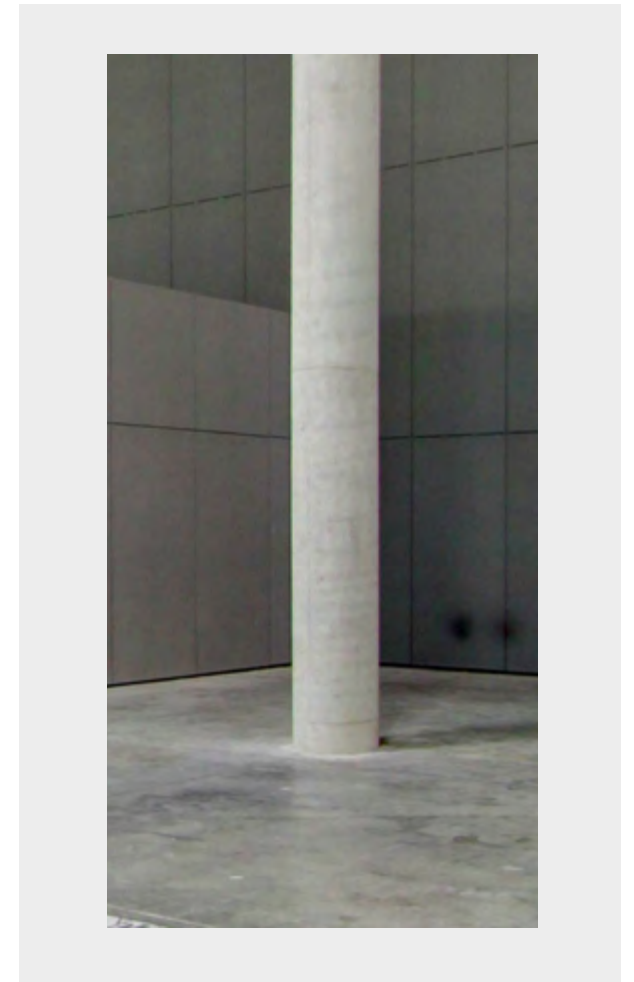

UNDERWALKWAY Floorplan

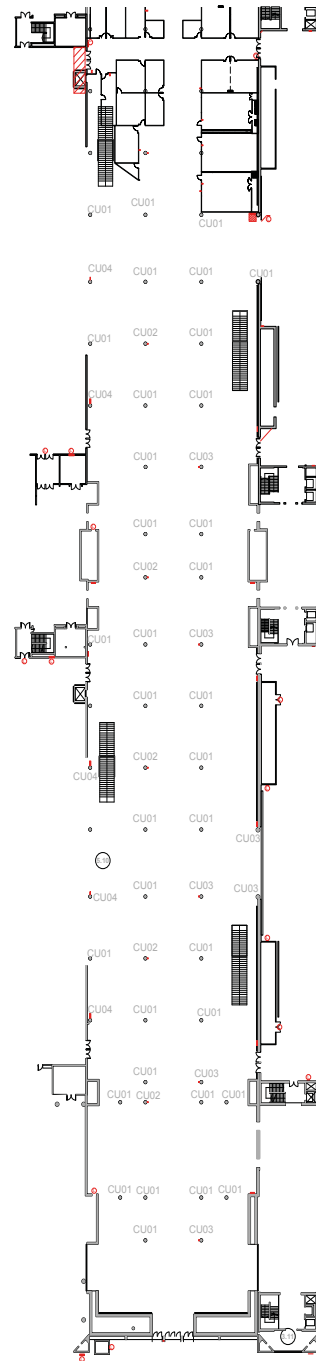

Column details - Gran Via Underwalkway Halls 4, 5, 6 and 7

Column type CU01

Floorplan & Dimensions

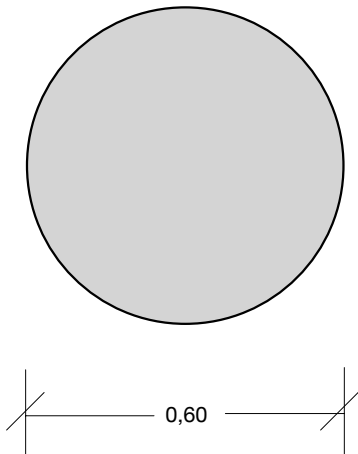

Picture

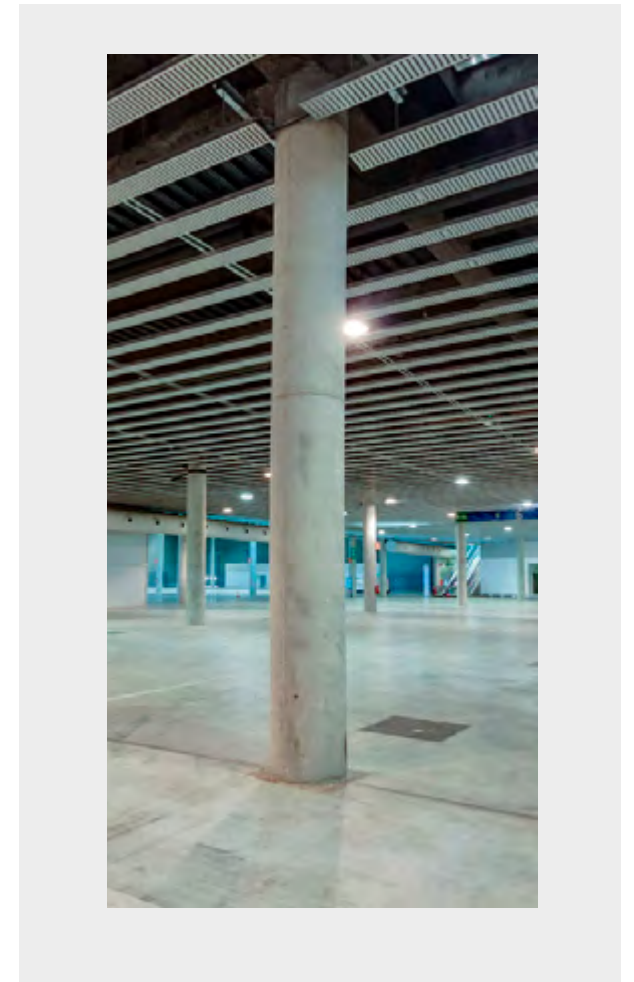

Column details - Gran Via Underwalkway Halls 4, 5, 6 and 7

Column type CU02

Floorplan & Dimensions

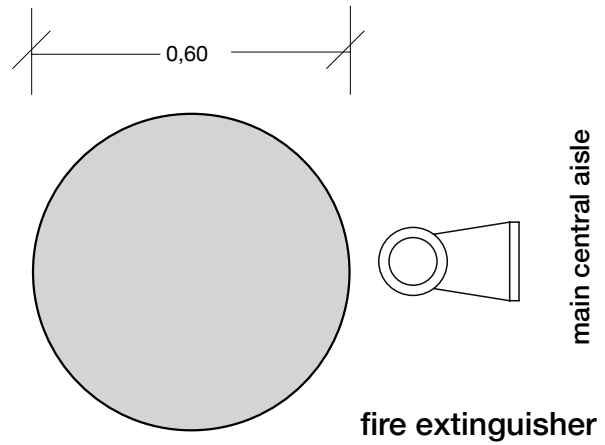

Picture

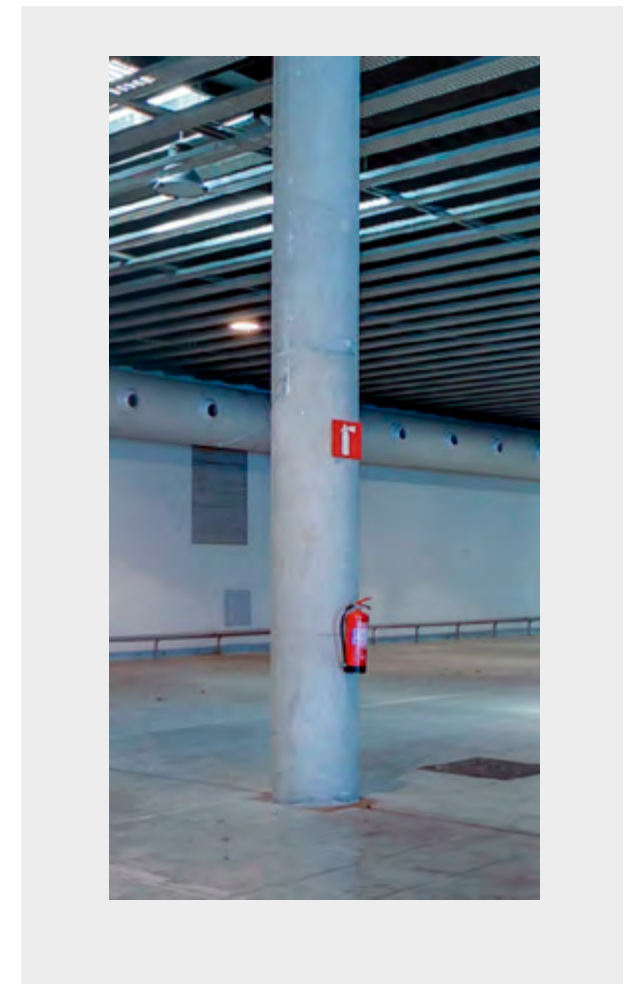

Column details - Gran Via Underwalkway Halls 4, 5, 6 and 7

Column type CU03

Floorplan & Dimensions

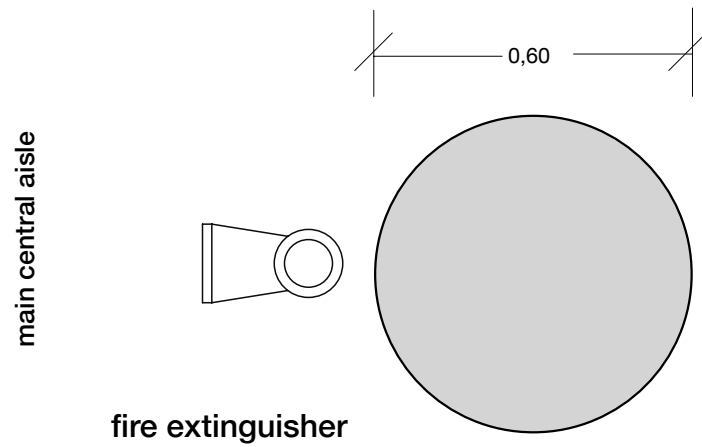

Picture

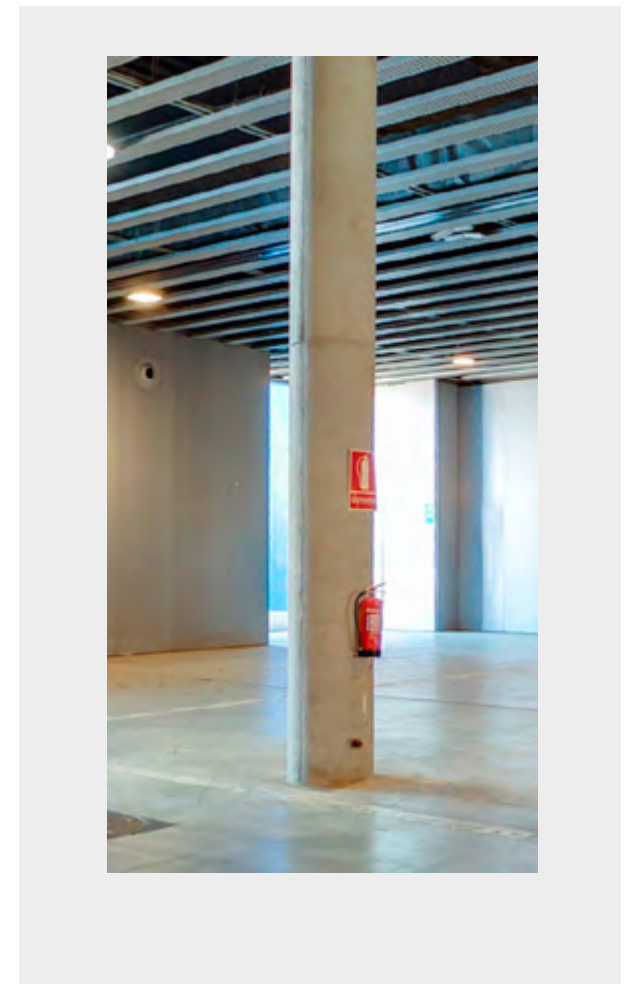

Column details - Gran Via Underwalkway Halls 4, 5, 6 and 7

Column type CU04

Floorplan & Dimensions

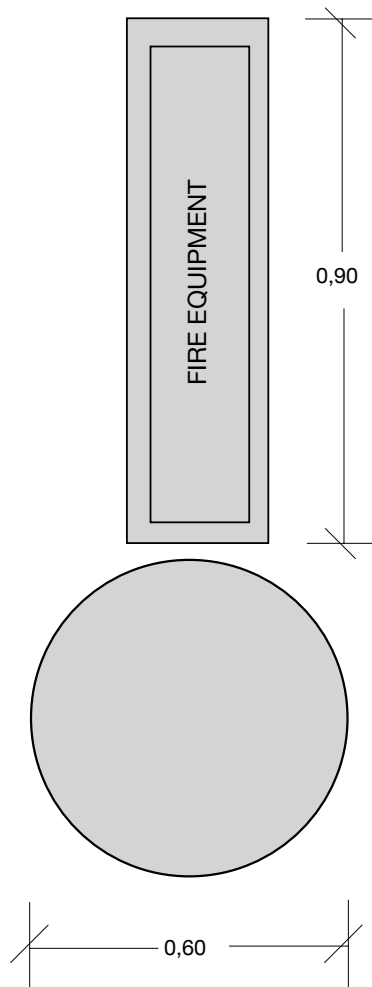

Picture

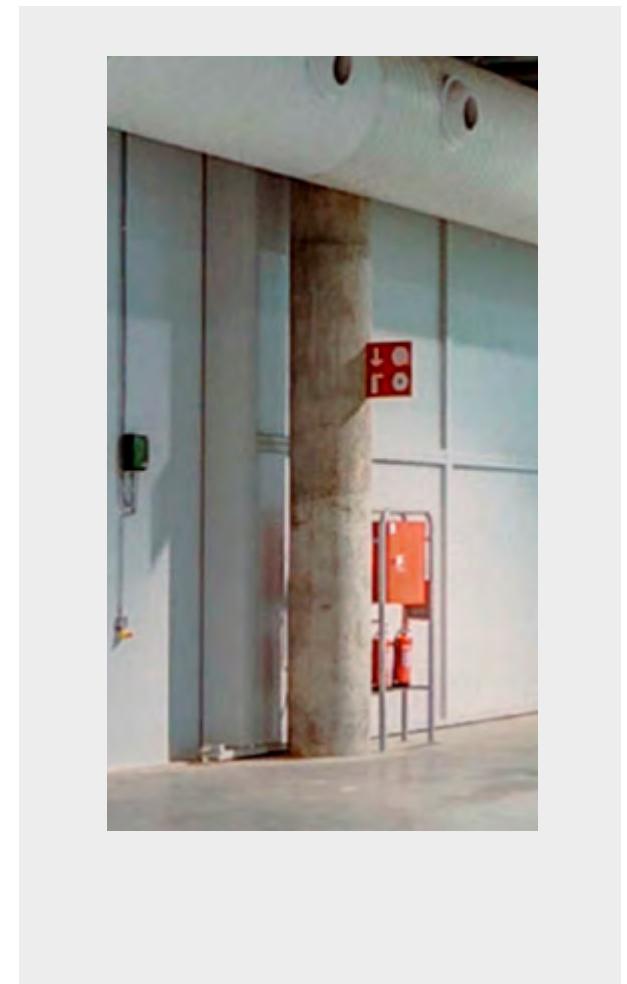

HALL 8.0 Floorplan

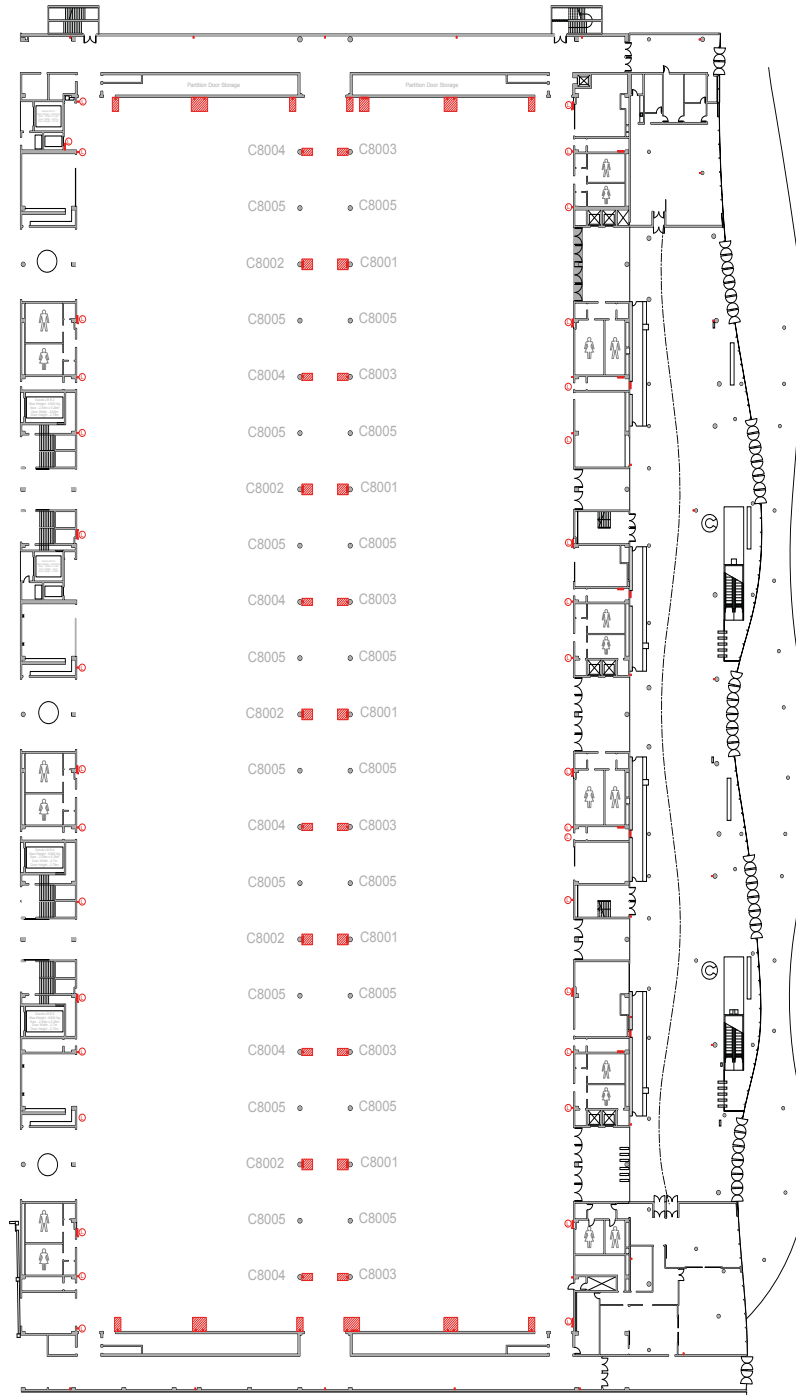

Column details - Gran Via Hall 8.0

Column type C8001

Floorplan & Dimensions

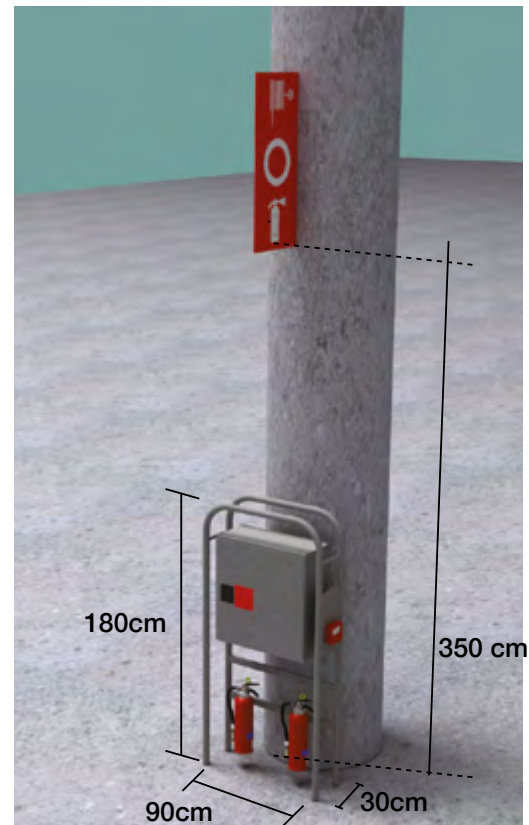
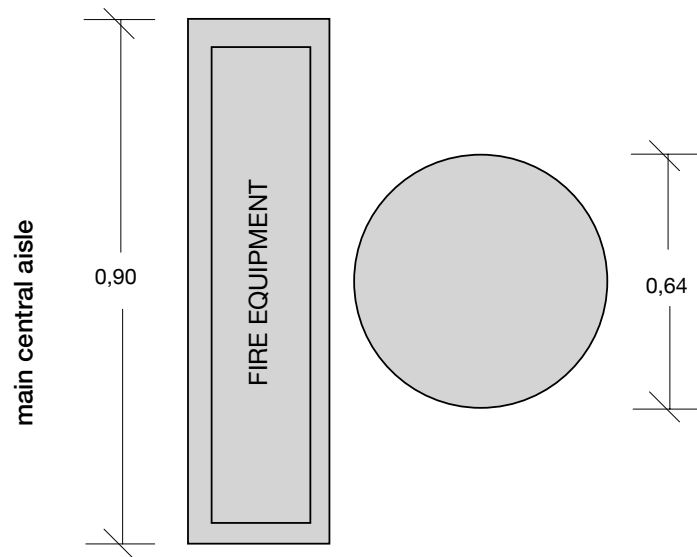

Note that the fire extinguisher equipment and sign need to remain accessible and visible at all times.

Picture

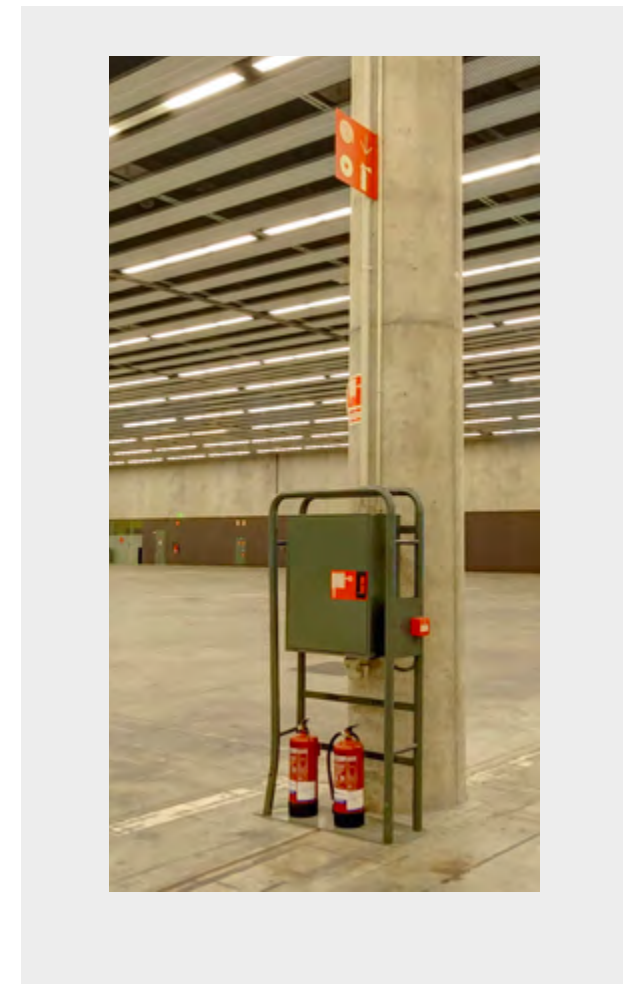

Column details - Gran Via Hall 8.0

Column type C8002

Floorplan & Dimensions

Picture

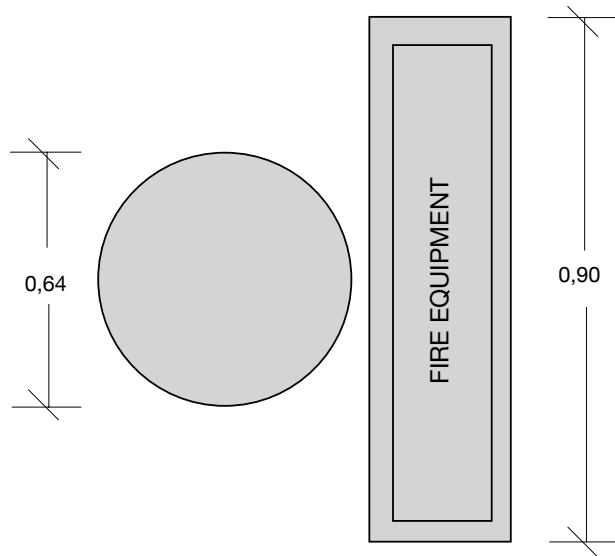

main central aisle

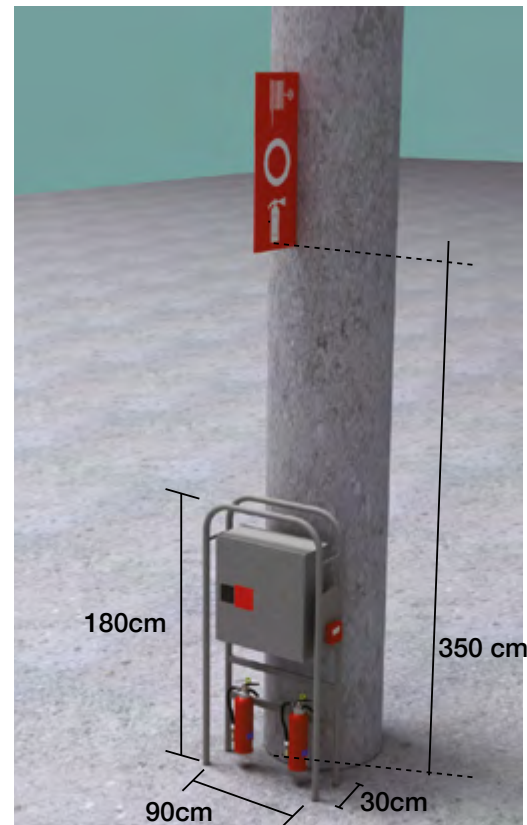

Note that the fire extinguisher equipment and sign need to remain accessible and visible at all times.

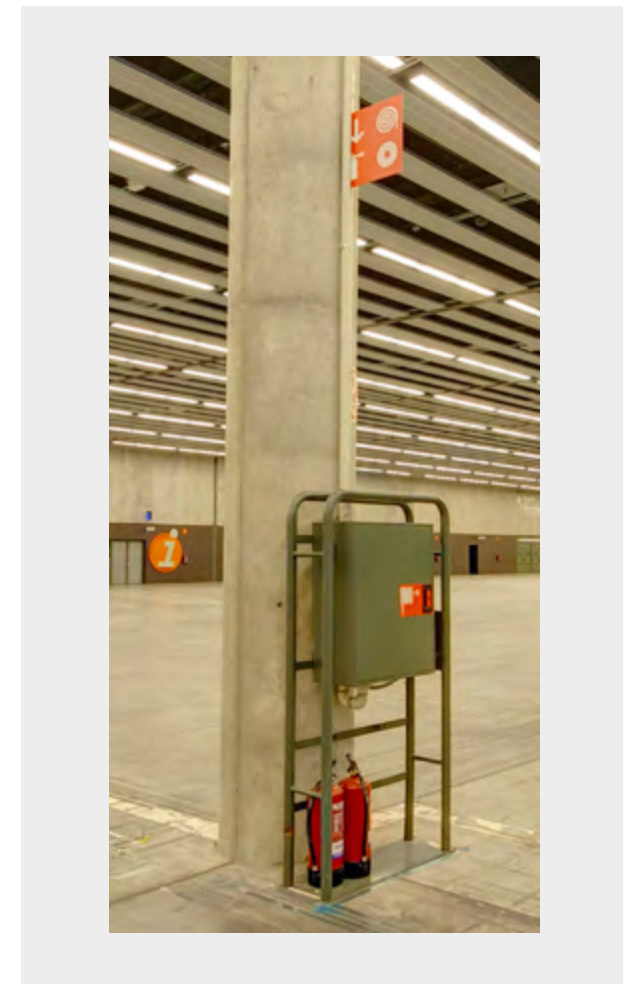

Column details - Gran Via Hall 8.0

Column type C8003

Floorplan & Dimensions

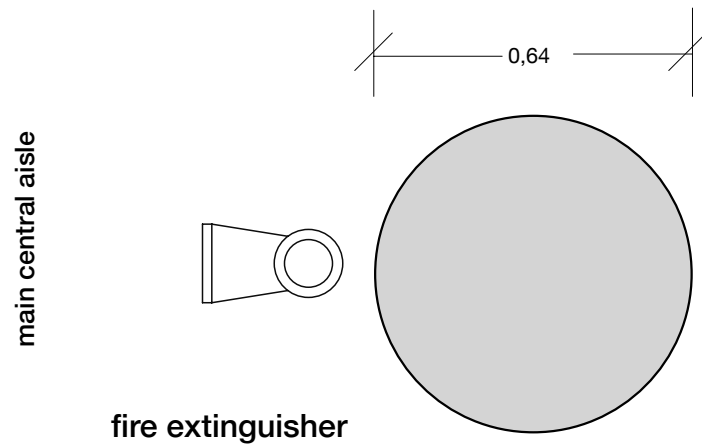

Picture

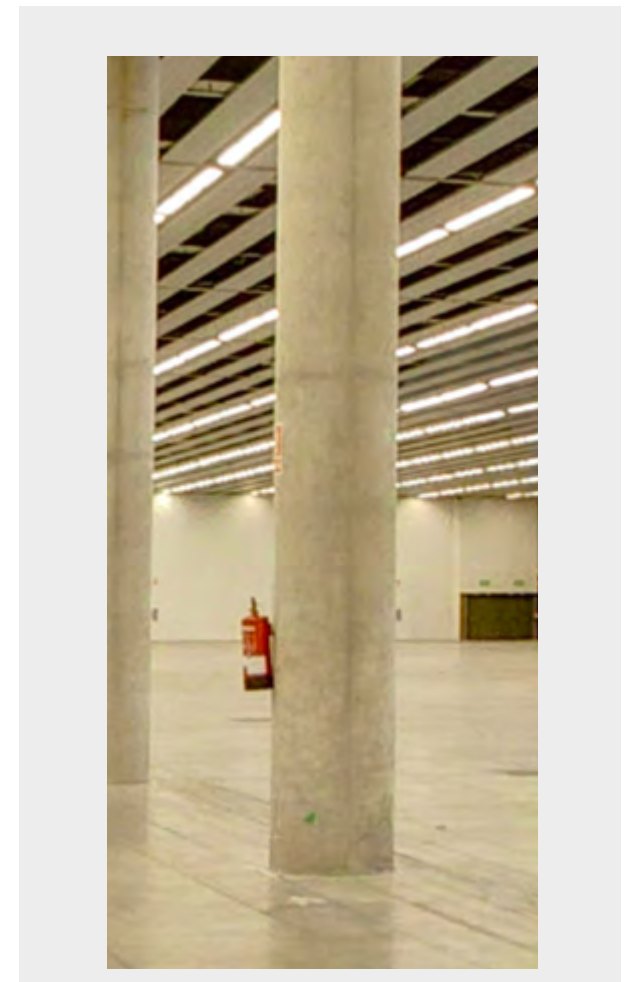

Column details - Gran Via Hall 8.0

Column type C8004

Floorplan & Dimensions

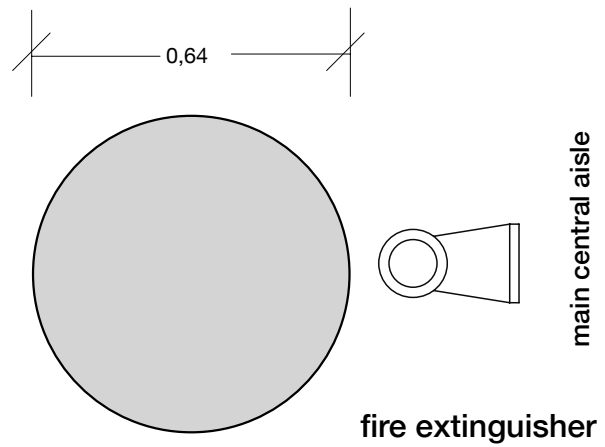

Picture

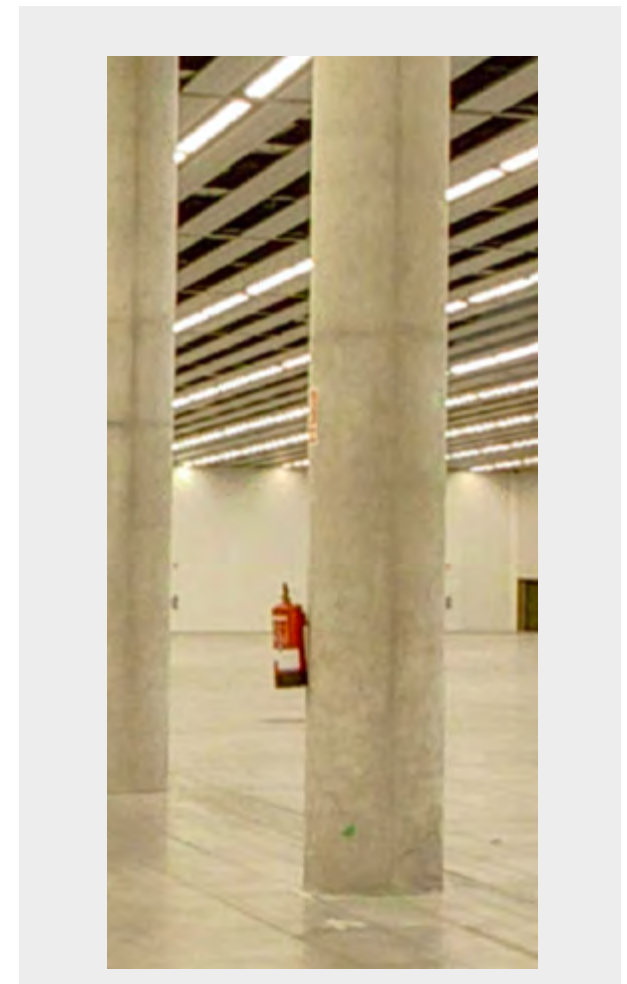

Column details - Gran Via Hall 8.0

Column type C8005

Floorplan & Dimensions

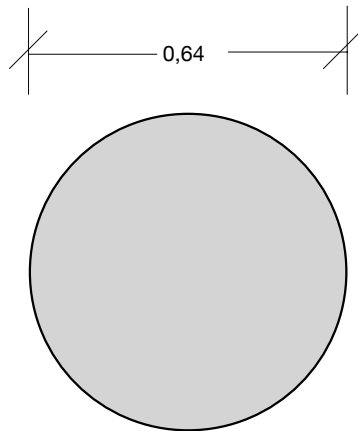

Picture



HALL 8.1 Floorplan

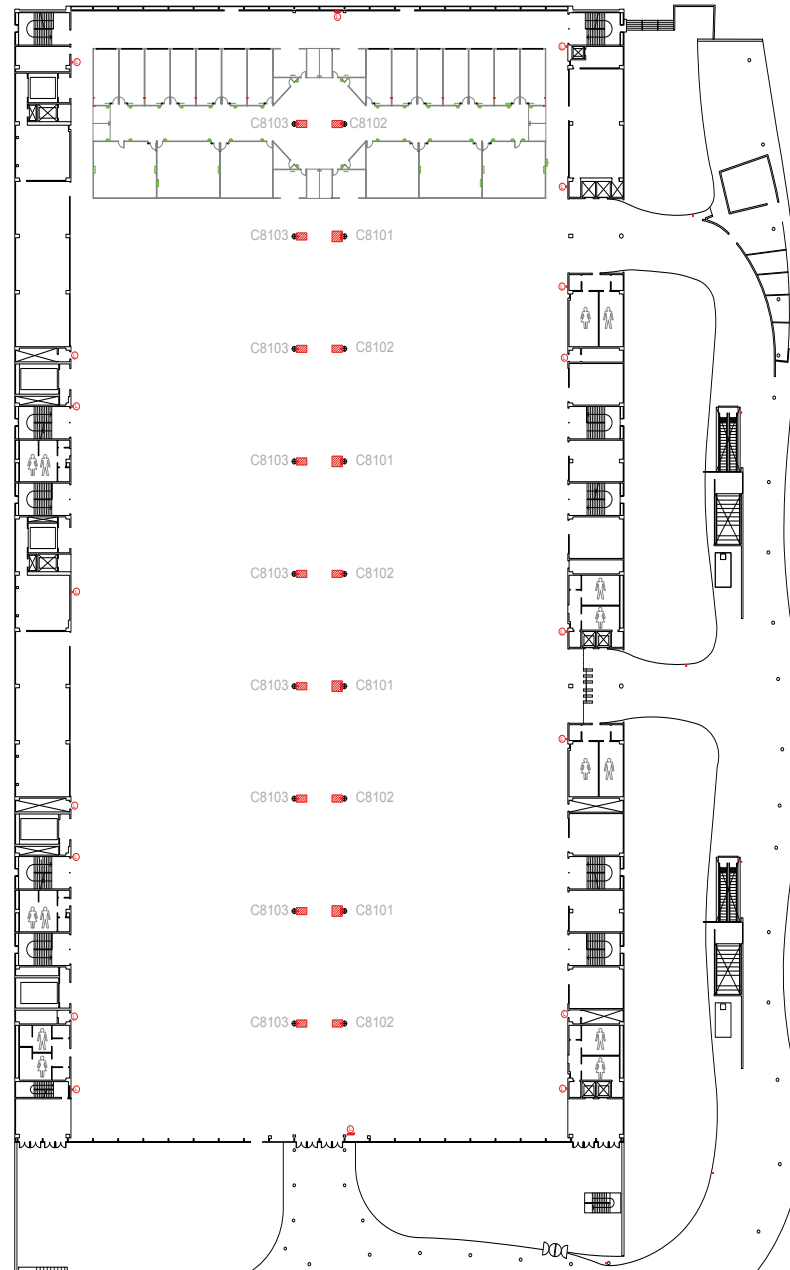

Column details - Gran Via Hall 8.1

Column type C8101

Floorplan & Dimensions

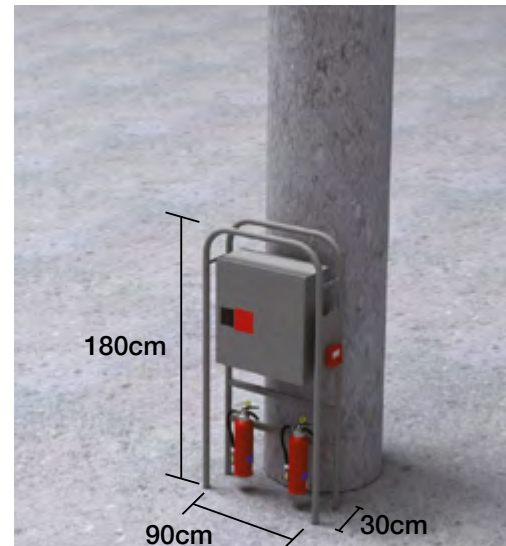
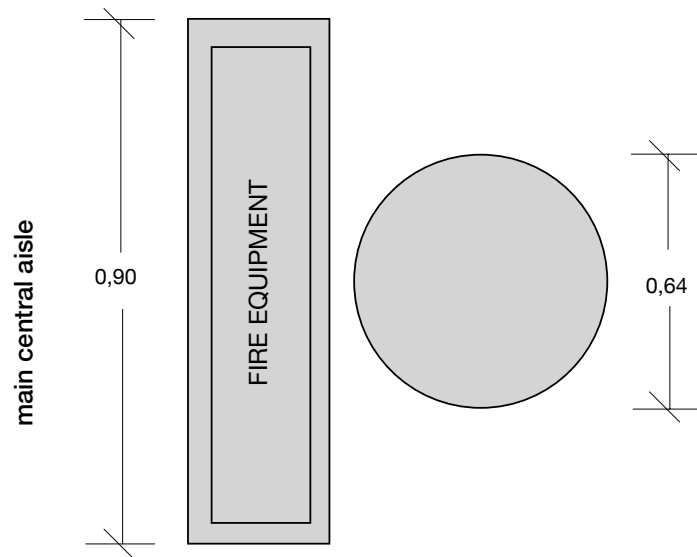

Note that the fire extinguisher equipment and sign need to remain accessible and visible at all times.

Picture

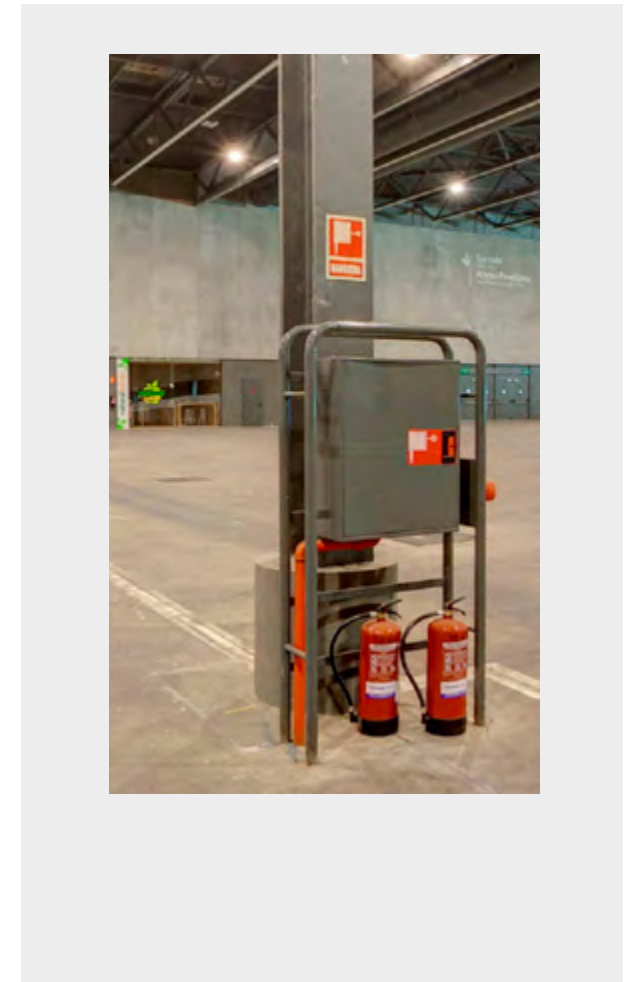

Column details - Gran Via Hall 8.1

Column type C8102

Floorplan & Dimensions

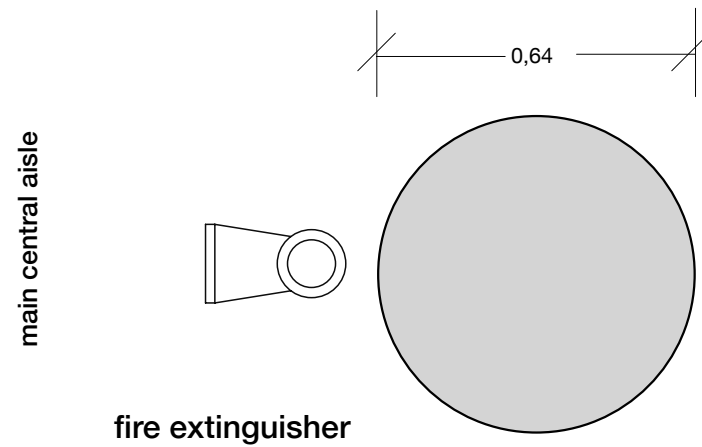

Picture

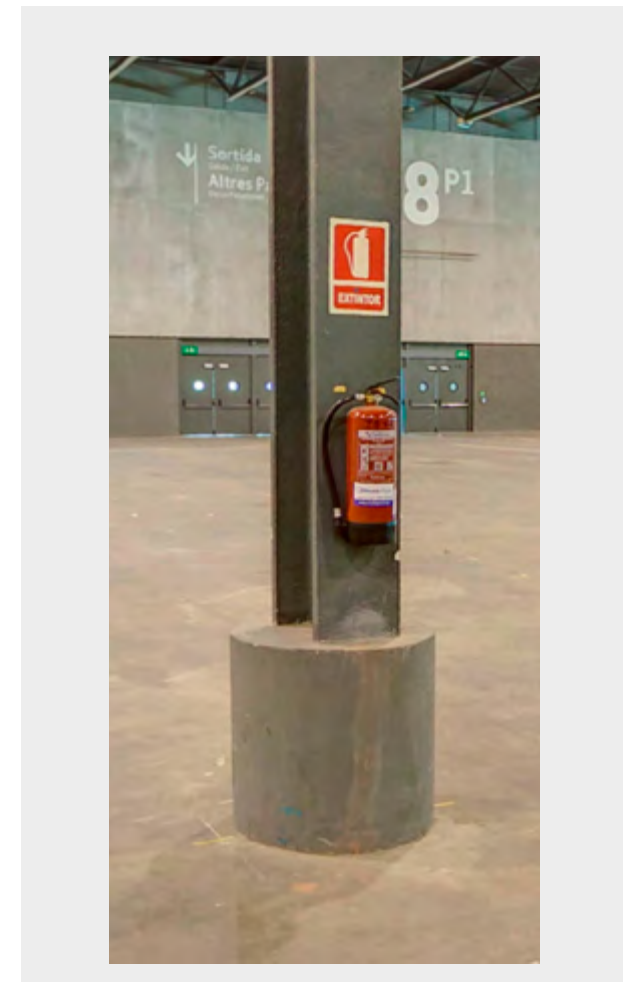

Column details - Gran Via Hall 8.1

Column type C8103

Floorplan & Dimensions

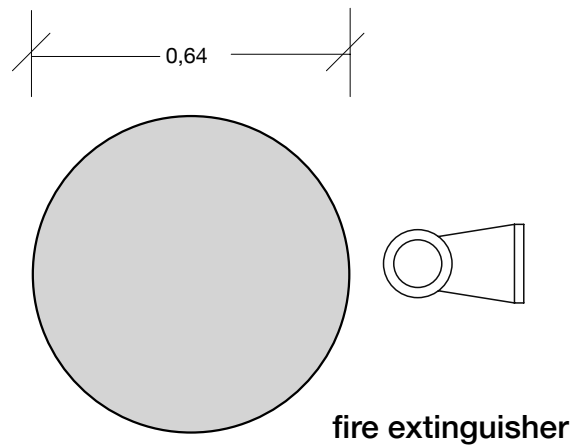

Picture

